

Description

The ZXTR1135PD8 is a high voltage regulator with fixed dual outputs of 5V and 13V giving up to 50mA drive per channel. It is designed for use in high voltage applications where standard linear regulators cannot be used. This function is fully integrated into a PowerDI[®] 5060-8 (Type B) package, minimizing PCB area and reducing number of components when compared with a multi-chip discrete solution. The high voltage regulator can deliver up to 100mA output current (Note 1).

Applications

Supply voltage regulation in:

- Networking
- Telecom
- Power Over Ethernet (PoE)

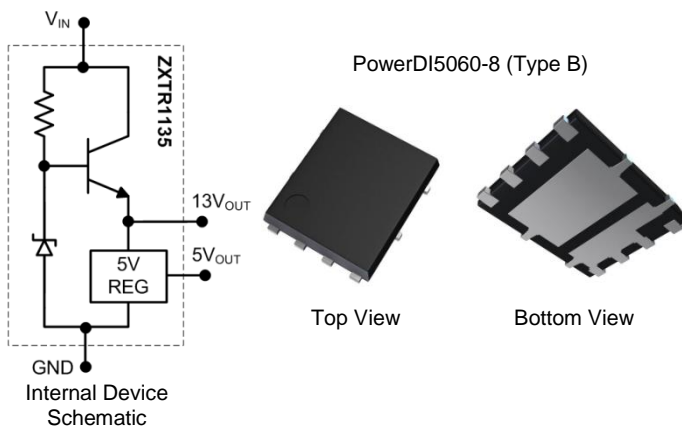

Features

- Series Linear Regulator Using Emitter-Follower Stage
- Input Voltage = 18 to 100V
- Output Voltage 1 = 5V ± 2%
- Output Voltage 2 = 13V ± 10%
- Output Current up to 50mA per Channel
- **Totally Lead-Free & Fully RoHS Compliant (Notes 2 & 3)**
- **Halogen and Antimony Free. "Green" Device (Note 4)**

Mechanical Data

- Case: PowerDI5060-8
- Case Material: Molded Plastic. "Green" Molding Compound. UL Flammability Rating 94V-0
- Moisture Sensitivity: Level 1 per J-STD-020
- Terminals: Finish - Matte Tin Plated Leads, Solderable per MIL-STD-202, Method 208⁽³⁾
- Weight: 0.104 grams (Approximate)

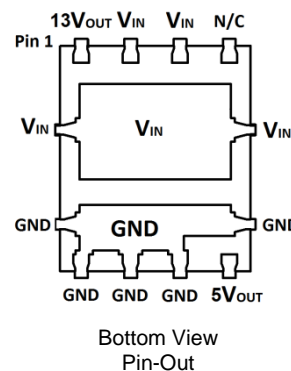

Pin Name	Pin Function
V _{IN}	Input Supply
GND	Power Ground
5V _{OUT}	5V Output
13V _{OUT}	13V Output
N/C	Not Connected

Ordering Information (Note 5)

Part Number	Marking	Reel Size (inches)	Tape Width (mm)	Quantity Per Reel
ZXTR1135PD8-13	ZXTR1135	13	12	2,500

- Notes:
1. Total 5V & 13V output currents not to exceed 100mA DC.
 2. No purposely added lead. Fully EU Directive 2002/95/EC (RoHS), 2011/65/EU (RoHS 2) & 2015/863/EU (RoHS 3) compliant.
 3. See <https://www.diodes.com/quality/lead-free/> for more information about Diodes Incorporated's definitions of Halogen- and Antimony-free, "Green" and Lead-free.
 4. Halogen- and Antimony-free "Green" products are defined as those which contain <900ppm bromine, <900ppm chlorine (<1500ppm total Br + Cl) and <1000ppm antimony compounds.
 5. For packaging details, go to our website at <https://www.diodes.com/design/support/packaging/diodes-packaging/>.

Marking Information

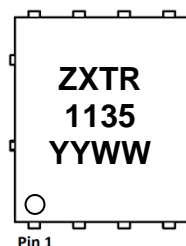

ZXTR1135 = Product Type Marking Code
 YYWW = Date Code Marking
 YY = Year (ex: 18 = 2018)
 WW = Week (01 to 52)

Absolute Maximum Ratings (Voltage relative to GND, @ $T_A = +25^\circ\text{C}$, unless otherwise specified.)

Characteristic		Symbol	Value	Unit
Input Voltage		V_{IN}	-0.3 to +100	V
Continuous Input & Output Current	5V _{OUT}	I_{IN}, I_{OUT}	100	mA
	13V _{OUT}		525	
Peak Pulsed Input & Output Current	5V _{OUT}	I_{IM}, I_{OM}	100	mA
	13V _{OUT}		2,000	

Maximum Current (@ $V_{IN} = 48\text{V}$, $T_A = +25^\circ\text{C}$, unless otherwise specified.)

Characteristic		Symbol	Value	Unit
Continuous Output Current	5V _{OUT} (Note 8)	I_{OUT}	50	mA
	13V _{OUT} (Note 9)		53	
Pulsed Output Current	5V _{OUT} (Note 10)	I_{OM}	100	mA
	13V _{OUT} (Note 11)		1,000	
	5V _{OUT} (Note 12)		100	
	13V _{OUT} (Note 13)		210	

Thermal Characteristics (@ $T_A = +25^\circ\text{C}$, unless otherwise specified.)

Characteristic		Symbol	Value	Unit
Power Dissipation	(Note 6)	P_D	1.85	W
	(Note 7)		0.94	
Thermal Resistance, Junction to Ambient	(Note 6)	$R_{\theta JA}$	54.1	$^\circ\text{C}/\text{W}$
	(Note 7)		106.4	
Thermal Resistance, Junction to Lead	(Note 14)	$R_{\theta JL}$	8	$^\circ\text{C}/\text{W}$
Thermal Resistance, Junction to Case	(Note 14)	$R_{\theta JC}$	15	
Maximum Operating Junction Temperature Range		T_J	-55 to +125	$^\circ\text{C}$
Storage Temperature Range		T_{STG}	-65 to +150	$^\circ\text{C}$

ESD Ratings (Note 15)

Characteristics	Symbols	Value	Unit	JEDEC Class
Electrostatic Discharge – Human Body Model	ESD HBM	4,000	V	3A
Electrostatic Discharge – Machine Model	ESD MM	400	V	C

- Notes:
- For a device mounted with the exposed V_{IN} pad on 50mm x 50mm 1oz copper that is on a single-sided 1.6mm FR-4 PCB; device is measured under still air conditions whilst operating in steady-state.
 - Same as note 6, except mounted on 15mm x 15mm 1oz copper.
 - Same as note 6, whilst operating at $V_{IN} = 48\text{V}$ and 13V output current is zero. Refer to Safe Operating Area for other Input Voltages.
 - Same as note 6, whilst operating at $V_{IN} = 48\text{V}$ and 5V output current is zero. Refer to Safe Operating Area for other Input Voltages.
 - Same as note 6, except measured with a single pulse width = 100 μs , $V_{IN} = 48\text{V}$ and 13V output current is zero. This is limited by the absolute maximum I_{OM} rating.
 - Same as note 6, except measured with a single pulse width = 100 μs , $V_{IN} = 48\text{V}$ and 5V output current is zero.
 - Same as note 6, except measured with a single pulse width = 10ms, $V_{IN} = 48\text{V}$ and 13V output current is zero. This is limited by the absolute maximum I_{OM} rating.
 - Same as note 6, except measured with a single pulse width = 10ms, $V_{IN} = 48\text{V}$ and 5V output current is zero.
 - $R_{\theta JL}$ = Thermal resistance from junction to solder-point (on the exposed V_{IN} pad).
 - $R_{\theta JC}$ = Thermal resistance from junction to the top of case.
 - Refer to JEDEC specification JESD22-A114 and JESD22-A115.

Thermal Characteristics and Derating Information

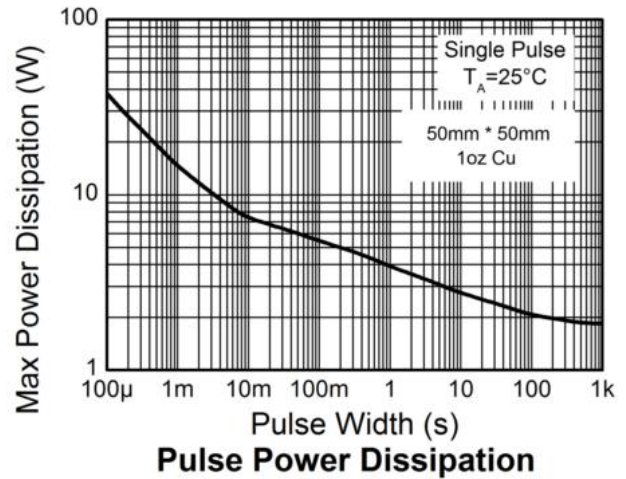
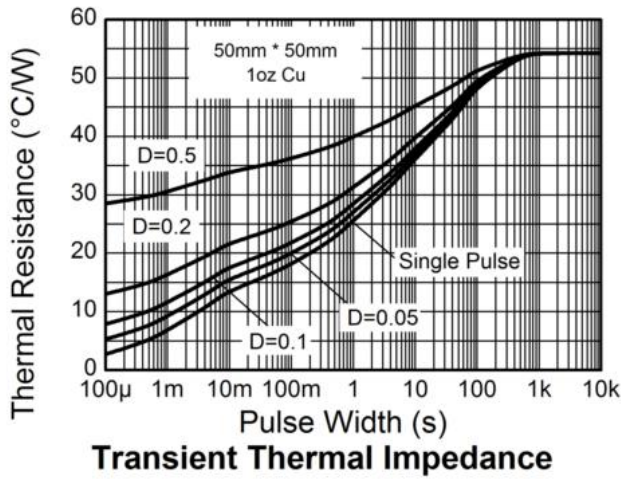
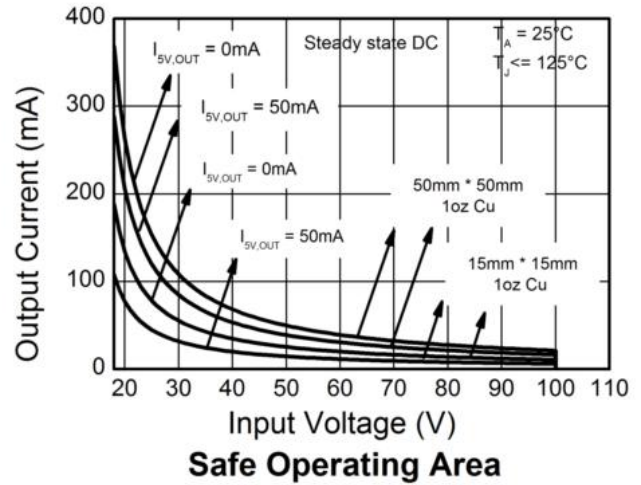
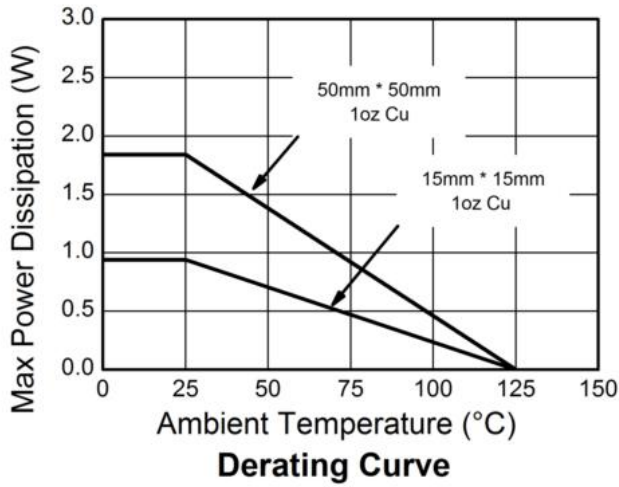

Electrical Characteristics (Voltage relative to GND, @T_A = +25°C, unless otherwise specified.)

Characteristic	Symbol	Min	Typ	Max	Unit	Test Condition
Minimum Value of Input Voltage Required to Maintain Line Regulation	V _{IN(MIN)}	18	—	—	V	—
5V Output						
Output Voltage (Note 16)	5V _{OUT}	4.9	5.0	5.1	V	V _{IN} = 48V, 5I _{OUT} = 15mA
Line Regulation (Notes 16 & 17)	Δ5V _{OUT}	-10	2	10	mV	V _{IN} = 18 to 72V, 5I _{OUT} = 15mA
Average Temperature Coefficient	Δ5V _{OUT} /ΔT	—	0.44	0.7	mV/°C	T _J = -55°C to +125°C V _{IN} = 48V, 5I _{OUT} = 15mA
Load Regulation (Notes 16 & 17)	Δ5V _{OUT}	—	20	50	mV	5I _{OUT} = 0.1 to 50mA, V _{IN} = 48V
Power Supply Rejection Ratio	ΔV _{IN} /Δ5V _{OUT}	—	57	—	dB	C _{OUT} = 100nF, 5I _{OUT} = 15mA, 5V _{OUT} = 5V, V _{IN} = 18 to 100V, f = 100Hz
13V Output						
Output Voltage (Note 16)	13V _{OUT}	11.7	13	14.3	V	V _{IN} = 48V, 13I _{OUT} = 15mA
Line Regulation (Notes 16 & 17)	Δ13V _{OUT}	—	390	900	mV	V _{IN} = 18 to 72V, 5I _{OUT} = 15mA
Temperature Coefficient	Δ13V _{OUT} /ΔT	—	10	—	mV/°C	T _J = -40°C to +125°C V _{IN} = 48V, 13I _{OUT} = 15mA
Load Regulation (Notes 16 & 18)	Δ13V _{OUT}	-500 -600	-320 -360	—	mV	13I _{OUT} = 0.1 to 30mA, V _{IN} = 48V 13I _{OUT} = 0.1 to 100mA, V _{IN} = 48V
Power Supply Rejection Ratio	ΔV _{IN} /Δ13V _{OUT}	—	45	—	dB	C _{OUT} = 100nF, 13I _{OUT} = 15mA, 13V _{OUT} = 13V, V _{IN} = 18 to 100V, f = 100Hz
Quiescent Current (Note 16)	I _Q	—	300 650	400 780	μA	V _{IN} = 48V, 13I _{OUT} = 10μA V _{IN} = 100V, 13I _{OUT} = 10μA

- Notes:
16. Measured under pulsed conditions. Pulse width ≤ 300μs. Duty cycle ≤ 2%.
 17. Line regulation $\Delta V_{OUT} = V_{OUT}(@ V_{IN} = 72V) - V_{OUT}(@ V_{IN} = 18V)$
 18. Load regulation $\Delta 5V_{OUT} = V_{OUT}(@ I_{OUT} = 50mA) - V_{OUT}(@ I_{OUT} = 0mA)$
 $\Delta 13V_{OUT} = V_{OUT}(@ I_{OUT} = 30mA) - V_{OUT}(@ I_{OUT} = 0.1mA)$

Pin Functions

Pin Name	Pin Function	Notes
V _{IN}	Input Supply	To maintain output regulation the input voltage can vary from 18 to 100V with respect to the GND pin. It is recommended to connect a 1μF capacitor to GND.
GND	Power Ground	This pin should be tied to the system ground.
5V _{OUT}	5V Output	Outputs a regulated 5V when drawing between 0.1 to 50mA current. It is recommended to connect a ≥100nF capacitor to GND to minimize the noise on the regulated output.
13V _{OUT}	13V Output	Outputs a regulated 13V when drawing between 0.1 to 100mA current. It is recommended to connect a ≥100nF capacitor to GND to minimize the noise on the regulated output.

Typical Application Circuit

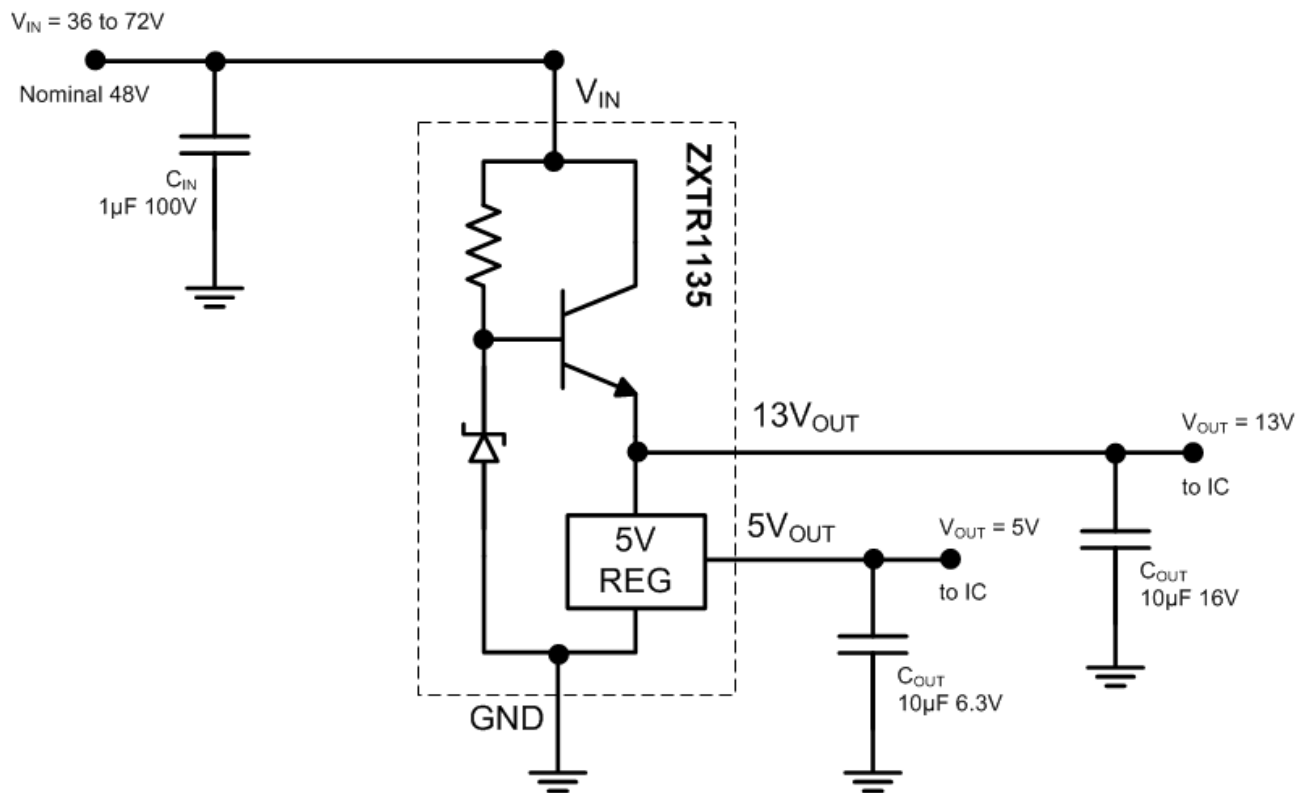

Example of a 5V and 13V regulated supply from a nominal 48V for powering two Controller IC's.

5V_{OUT} Typical Electrical Characteristics (@T_A = +25°C, unless otherwise specified.)

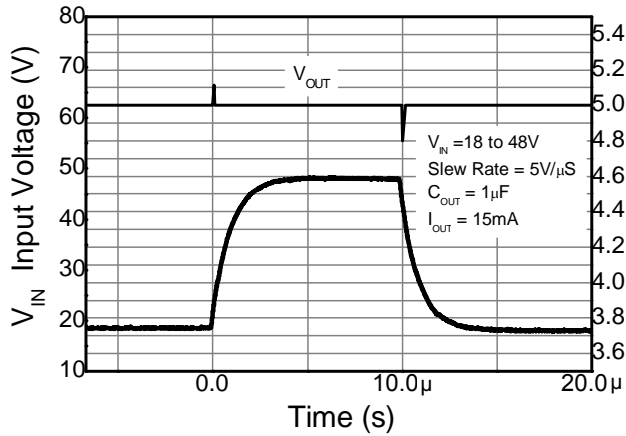

Line Transient Response

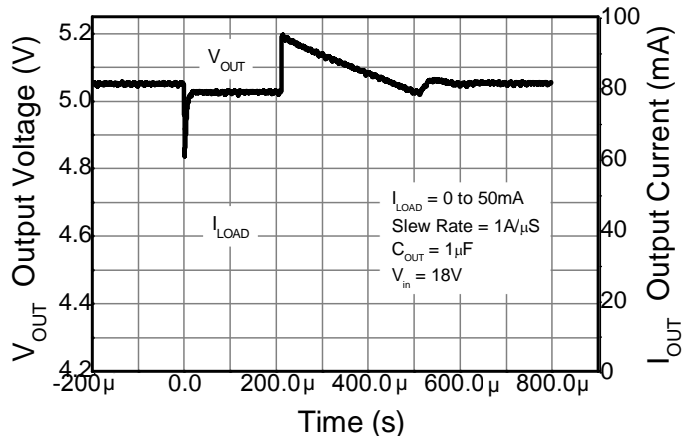

Load Transient Response

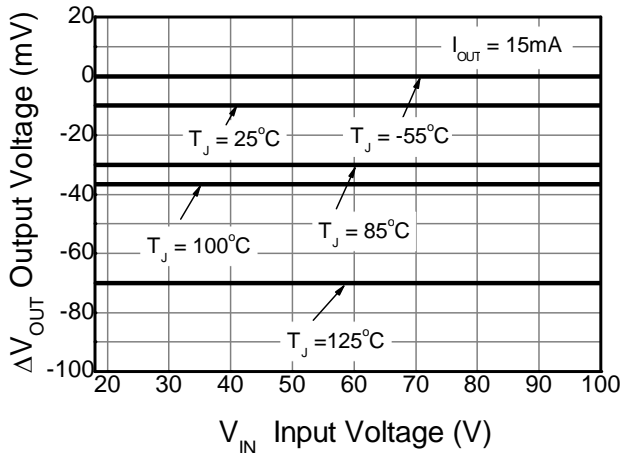

Line Regulation (Note 15)

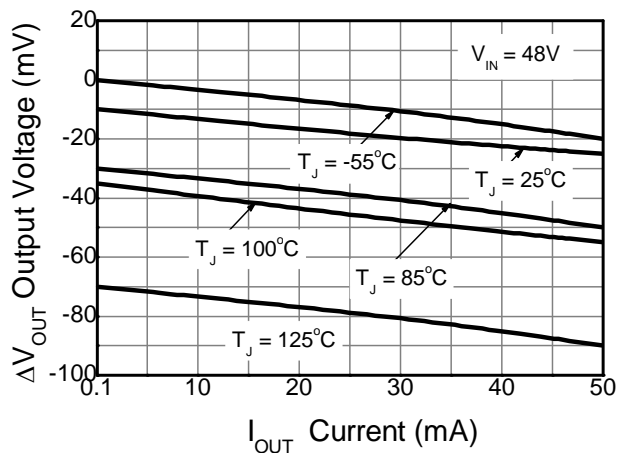

Load Regulation (Note 16)

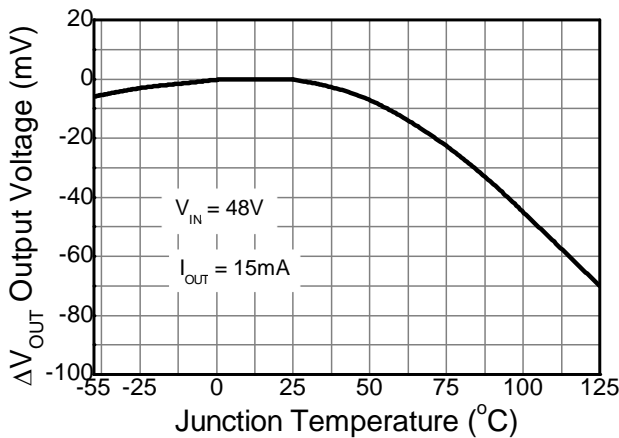

Temperature Coefficient (Note 17)

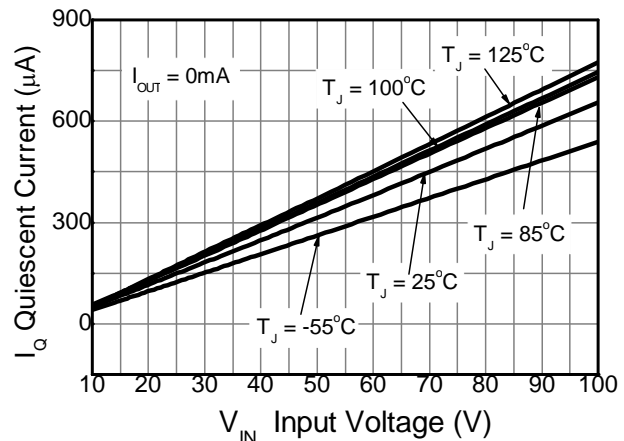

Quiescent Current

13V_{OUT} Typical Electrical Characteristics (Cont.) (@T_A = +25°C, unless otherwise specified.)

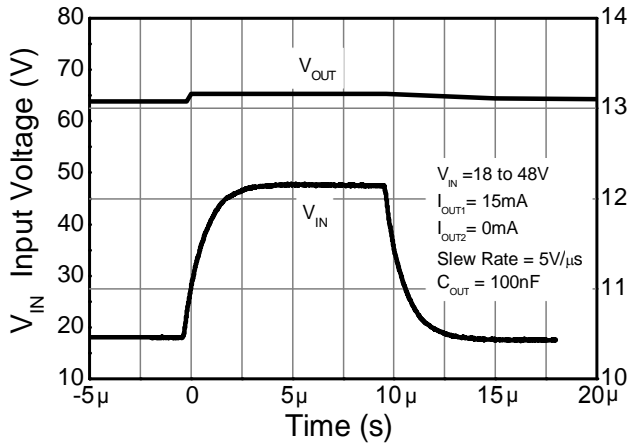

Line Transient Response

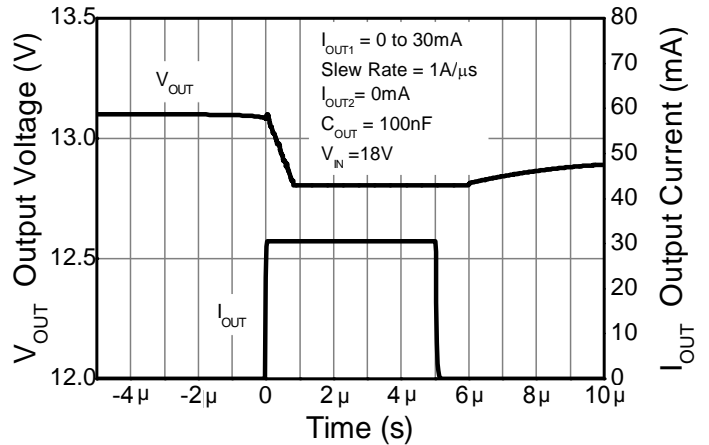

Load Transient Response

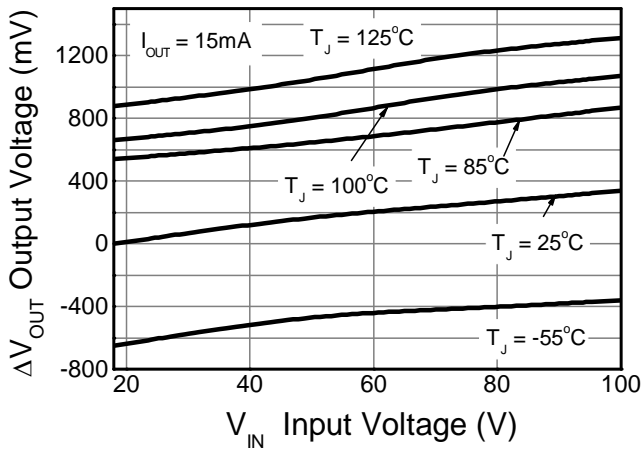

Line Regulation (Note 15)

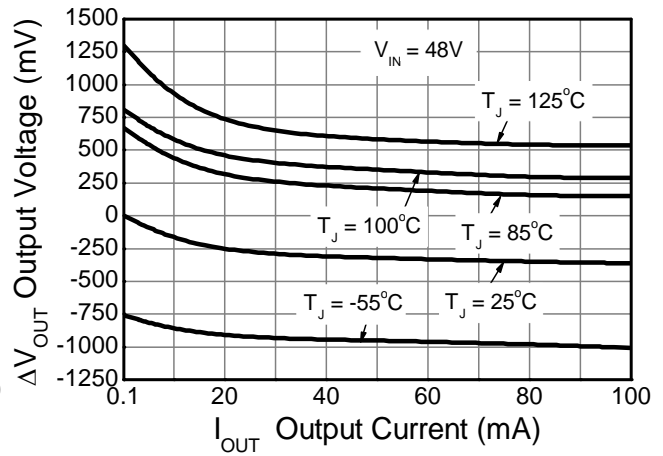

Load Regulation (Note 16)

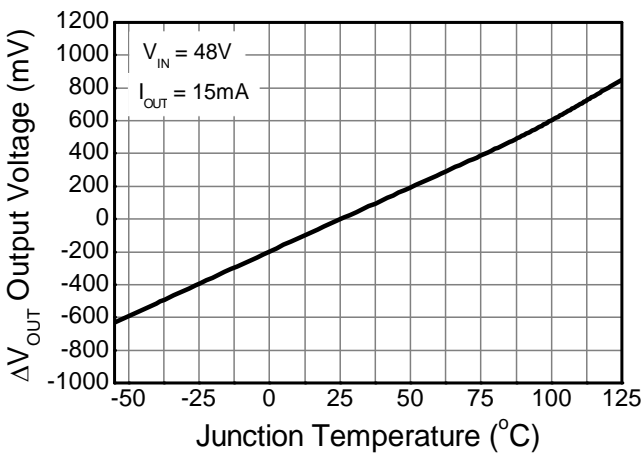

Temperature Coefficient (Note 17)

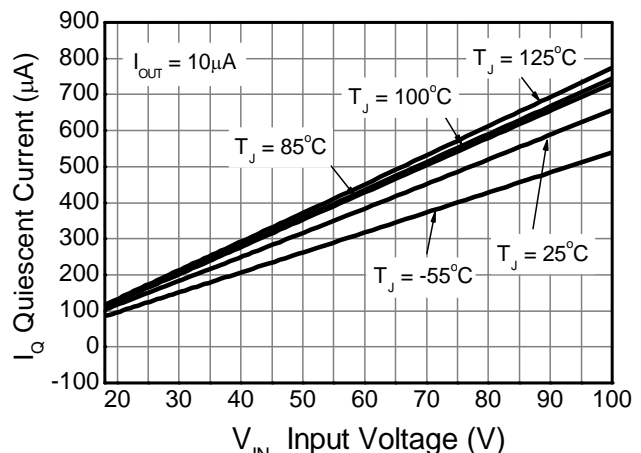

Quiescent Current

Package Outline Dimensions

Please see <http://www.diodes.com/package-outlines.html> for the latest version.

PowerDI5060-8 (Type B)

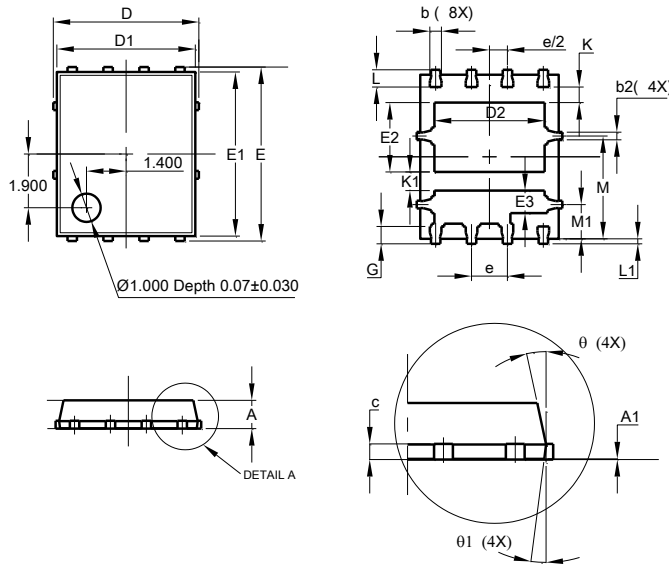

PowerDI5060-8 (Type B)			
Dim	Min	Max	Typ
A	0.90	1.10	1.00
A1	0.00	0.05	—
b	0.33	0.51	0.41
b2	0.20	0.40	0.273
c	0.230	0.330	0.273
D	5.15 BSC		
D1	4.70	5.10	4.90
D2	3.50	4.40	3.90
E	6.15 BSC		
E1	5.60	6.00	5.80
E2	2.25	2.65	2.45
E3	0.595	0.995	0.795
e	1.27 BSC		
G	0.51	0.71	0.61
K	0.51	—	—
K1	0.51	—	—
L	0.51	0.71	0.61
L1	0.05	0.20	0.175
M	3.235	4.035	3.635
M1	1.00	1.40	1.21
θ1	10°	12°	11°
θ2	6°	8°	7°
All Dimensions in mm			

Suggested Pad Layout

Please see <http://www.diodes.com/package-outlines.html> for the latest version.

PowerDI5060-8 (Type B)

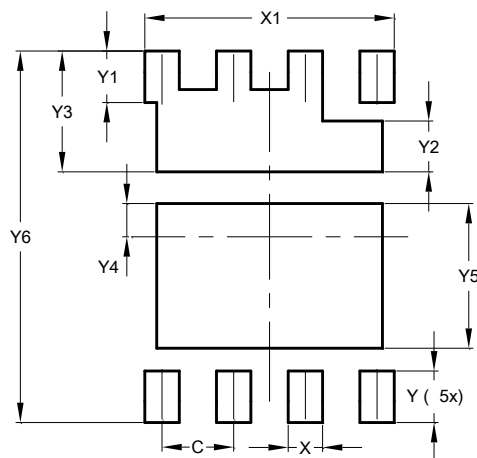

Dimensions	Value (in mm)
C	1.270
X	0.610
X1	4.420
Y	0.910
Y1	0.910
Y2	0.895
Y3	2.130
Y4	0.585
Y5	2.550
Y6	6.550

IMPORTANT NOTICE

DIODES INCORPORATED MAKES NO WARRANTY OF ANY KIND, EXPRESS OR IMPLIED, WITH REGARDS TO THIS DOCUMENT, INCLUDING, BUT NOT LIMITED TO, THE IMPLIED WARRANTIES OF MERCHANTABILITY AND FITNESS FOR A PARTICULAR PURPOSE (AND THEIR EQUIVALENTS UNDER THE LAWS OF ANY JURISDICTION).

Diodes Incorporated and its subsidiaries reserve the right to make modifications, enhancements, improvements, corrections or other changes without further notice to this document and any product described herein. Diodes Incorporated does not assume any liability arising out of the application or use of this document or any product described herein; neither does Diodes Incorporated convey any license under its patent or trademark rights, nor the rights of others. Any Customer or user of this document or products described herein in such applications shall assume all risks of such use and will agree to hold Diodes Incorporated and all the companies whose products are represented on Diodes Incorporated website, harmless against all damages.

Diodes Incorporated does not warrant or accept any liability whatsoever in respect of any products purchased through unauthorized sales channel. Should Customers purchase or use Diodes Incorporated products for any unintended or unauthorized application, Customers shall indemnify and hold Diodes Incorporated and its representatives harmless against all claims, damages, expenses, and attorney fees arising out of, directly or indirectly, any claim of personal injury or death associated with such unintended or unauthorized application.

Products described herein may be covered by one or more United States, international or foreign patents pending. Product names and markings noted herein may also be covered by one or more United States, international or foreign trademarks.

This document is written in English but may be translated into multiple languages for reference. Only the English version of this document is the final and determinative format released by Diodes Incorporated.

LIFE SUPPORT

Diodes Incorporated products are specifically not authorized for use as critical components in life support devices or systems without the express written approval of the Chief Executive Officer of Diodes Incorporated. As used herein:

A. Life support devices or systems are devices or systems which:

1. are intended to implant into the body, or
2. support or sustain life and whose failure to perform when properly used in accordance with instructions for use provided in the labeling can be reasonably expected to result in significant injury to the user.

B. A critical component is any component in a life support device or system whose failure to perform can be reasonably expected to cause the failure of the life support device or to affect its safety or effectiveness.

Customers represent that they have all necessary expertise in the safety and regulatory ramifications of their life support devices or systems, and acknowledge and agree that they are solely responsible for all legal, regulatory and safety-related requirements concerning their products and any use of Diodes Incorporated products in such safety-critical, life support devices or systems, notwithstanding any devices- or systems-related information or support that may be provided by Diodes Incorporated. Further, Customers must fully indemnify Diodes Incorporated and its representatives against any damages arising out of the use of Diodes Incorporated products in such safety-critical, life support devices or systems.

Copyright © 2018, Diodes Incorporated

www.diodes.com

Mouser Electronics

Authorized Distributor

Click to View Pricing, Inventory, Delivery & Lifecycle Information:

[Diodes Incorporated:](#)

[ZXTR1135PD8-13](#)