



**ELECTROSTATIC SENSITIVE DEVICE**  
OBSERVE HANDLING PRECAUTIONS

# RA60H4047M1

RoHS Compliance, 400-470MHz 60W 12.5V, 2 Stage Amp. For MOBILE RADIO

## DESCRIPTION

The RA60H4047M1 is a 60-watt RF MOSFET Amplifier Module for 12.5-volt mobile radios that operate in the 400- to 470-MHz range.

The battery can be connected directly to the drain of the enhancement-mode MOSFET transistors. Without the gate voltage ( $V_{GG}=0V$ ), only a small leakage current flows into the drain and the nominal output signal ( $P_{out}=60W$ ) attenuates up to 60 dB. The output power and the drain current increase as the gate voltage increases. The output power and the drain current increase substantially with the gate voltage around 0V(minimum). The nominal output power becomes available at the state that  $V_{GG}$  is 4V (typical) and 5V (maximum). At  $V_{GG}=5V$ , the typical gate currents are 5mA. This module is designed for non-linear FM modulation, but may also be used for linear modulation by setting the drain quiescent current with the gate voltage and controlling the output power with the input power.

## FEATURES

- Enhancement-Mode MOSFET Transistors ( $I_{DD}\approx 0$  @  $V_{DD}=12.5V$ ,  $V_{GG}=0V$ )
- $P_{out}>60W$ ,  $\eta_T>40\%$  @  $V_{DD}=12.5V$ ,  $V_{GG}=5V$ ,  $P_{in}=50mW$
- Broadband Frequency Range: 400-470MHz
- Metal shield structure that makes the improvements of spurious radiation simple
- Low-Power Control Current  $I_{GG}=5mA$  (typ) @  $V_{GG}=5V$
- Module Size: 67 x 18 x 9.9 mm
- Linear operation is possible by setting the quiescent drain current with the gate voltages and controlling the output power with the input power.

## RoHS COMPLIANCE

- RA60H4047M1 is a RoHS compliant product.
  - RoHS compliance is indicate by the letter "G" after the Lot Marking.
  - This product include the lead in the Glass of electronic parts and the lead in electronic Ceramic parts.
- However, it is applicable to the following exceptions of RoHS Directions.
1. Lead in the Glass of a cathode-ray tube, electronic parts, and fluorescent tubes.
  2. Lead in electronic Ceramic parts.

## ORDERING INFORMATION:

ORDER NUMBER	SUPPLY FORM
RA60H4047M1-101	Antistatic tray, 10 modules/tray

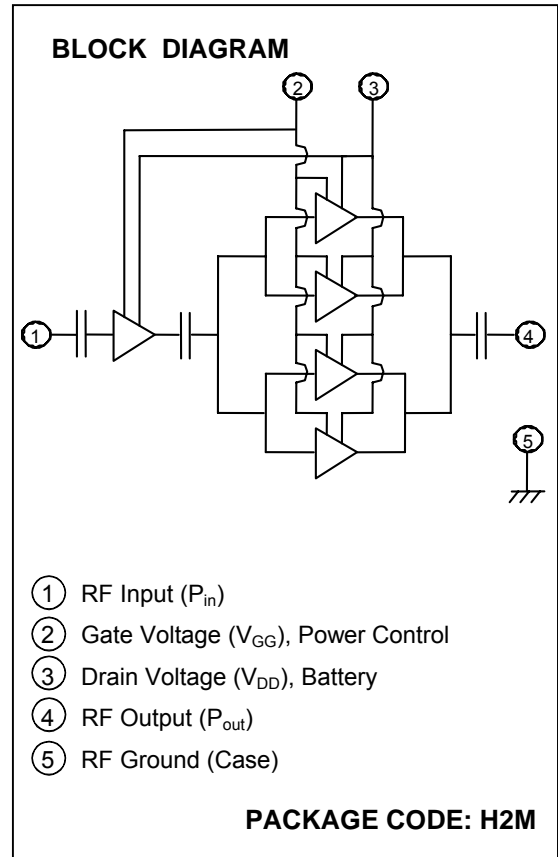



**MAXIMUM RATINGS** ( $T_{case}=+25^{\circ}\text{C}$ ,  $Z_G=Z_L=50\Omega$ , unless otherwise specified)

SYMBOL	PARAMETER	CONDITIONS	RATING	UNIT
$V_{DD}$	Drain Voltage	$V_{GG}<5\text{V}$ , $P_{in}=0\text{W}$	17	V
$V_{GG}$	Gate Voltage	$V_{DD}<12.5\text{V}$ , $P_{in}=50\text{mW}$	6	V
$P_{in}$	Input Power	$f=400\text{-}470\text{MHz}$ , $V_{GG}<5\text{V}$	100	mW
$P_{out}$	Output Power		80	W
$T_{case(OP)}$	Operation Case Temperature Range		-30 to +100	$^{\circ}\text{C}$
$T_{stg}$	Storage Temperature Range		-40 to +110	$^{\circ}\text{C}$

The above parameters are independently guaranteed.

**ELECTRICAL CHARACTERISTICS** ( $T_{case}=+25^{\circ}\text{C}$ ,  $Z_G=Z_L=50\Omega$ , unless otherwise specified)

SYMBOL	PARAMETER	CONDITIONS	MIN	TYP	MAX	UNIT
F	Frequency Range		400		470	MHz
$P_{out}$	Output Power	$V_{DD}=12.5\text{V}$	60			W
$\eta_T$	Total Efficiency	$V_{GG}=5\text{V}$	40			%
$2f_o$	2 <sup>nd</sup> Harmonic	$P_{in}=50\text{mW}$			-40	dBc
$\rho_{in}$	Input VSWR				3:1	—
$I_{GG}$	Gate Current	$V_{DD}=0\text{V}$ , $V_{GG}=5\text{V}$ , $P_{in}=0\text{W}$		5	6	mA
$I_{DD}$	Leakage Current	$V_{DD}=17\text{V}$ , $V_{GG}=0\text{V}$ , $P_{in}=0\text{W}$			1	mA
—	Stability	$V_{DD}=10.0\text{-}15.2\text{V}$ , $P_{in}=25\text{-}70\text{mW}$ , $5<P_{out}<65\text{W}$ ( $V_{GG}$ control), Load VSWR=3:1	No parasitic oscillation			—
—	Load VSWR Tolerance	$V_{DD}=15.2\text{V}$ , $P_{in}=50\text{mW}$ , $P_{out}=60\text{W}$ ( $V_{GG}$ control), Load VSWR=20:1	No degradation or destroy			—

All parameters, conditions, ratings, and limits are subject to change without notice.



TYPICAL PERFORMANCE ( $T_{case}=+25^{\circ}C$ ,  $Z_G=Z_L=50\Omega$ , unless otherwise specified)

OUTPUT POWER, TOTAL EFFICIENCY, versus FREQUENCY

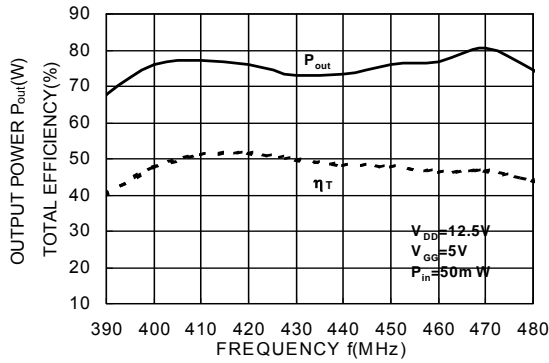

2<sup>nd</sup>, 3<sup>rd</sup> HARMONICS versus FREQUENCY

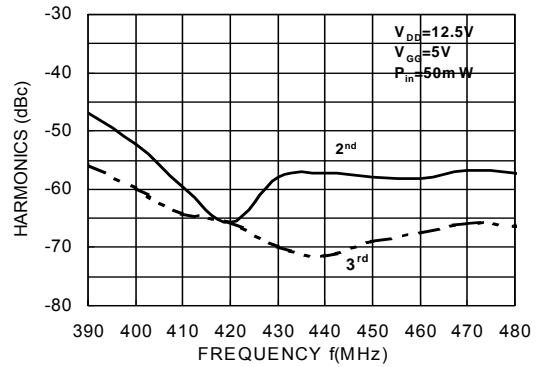

INPUT VSWR versus FREQUENCY

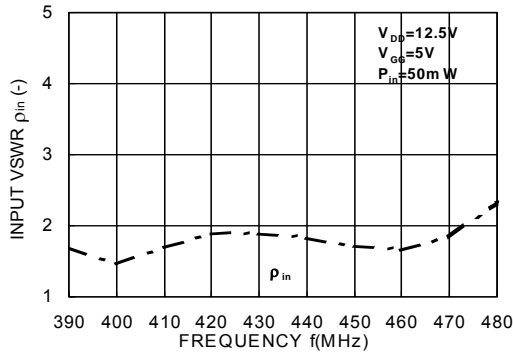

GATE CURRENT versus FREQUENCY

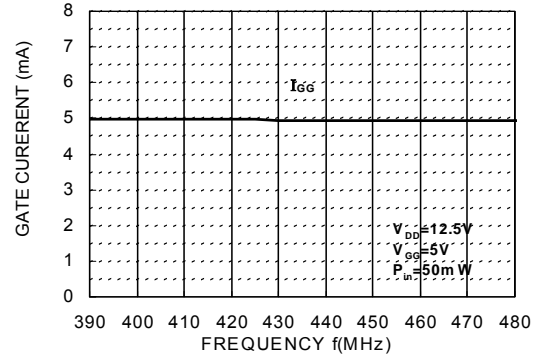

OUTPUT POWER, POWER GAIN and DRAIN CURRENT versus INPUT POWER

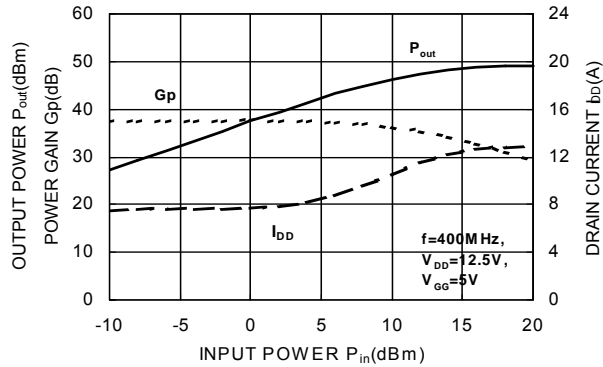

OUTPUT POWER, POWER GAIN and DRAIN CURRENT versus INPUT POWER

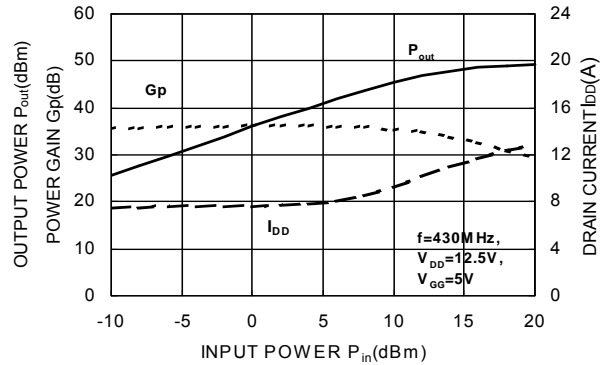

OUTPUT POWER, POWER GAIN and DRAIN CURRENT versus INPUT POWER

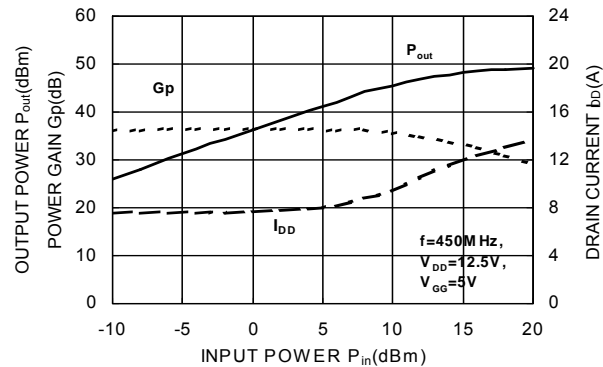

OUTPUT POWER, POWER GAIN and DRAIN CURRENT versus INPUT POWER

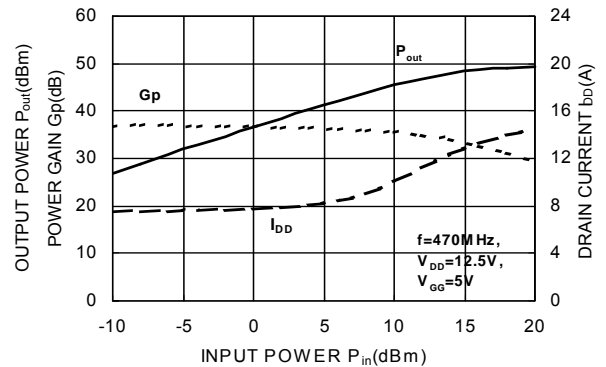



TYPICAL PERFORMANCE ( $T_{case}=+25^{\circ}C$ ,  $Z_G=Z_L=50\Omega$ , unless otherwise specified)

OUTPUT POWER and DRAIN CURRENT versus DRAIN VOLTAGE

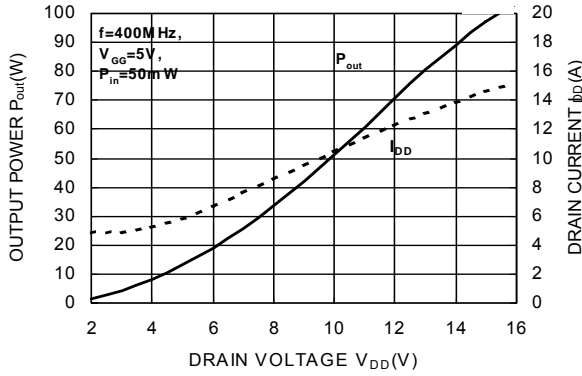

OUTPUT POWER and DRAIN CURRENT versus DRAIN VOLTAGE

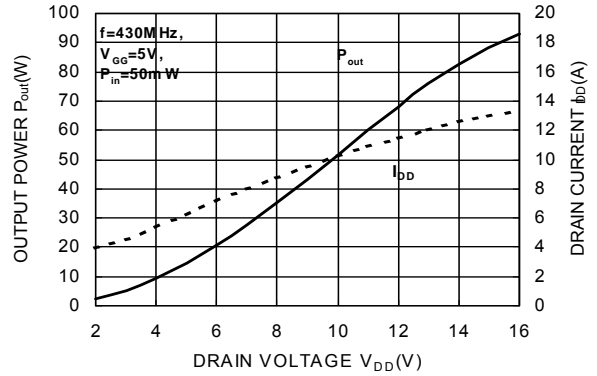

OUTPUT POWER and DRAIN CURRENT versus DRAIN VOLTAGE

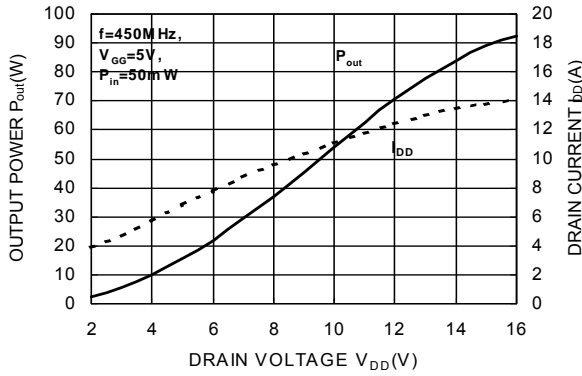

OUTPUT POWER and DRAIN CURRENT versus DRAIN VOLTAGE

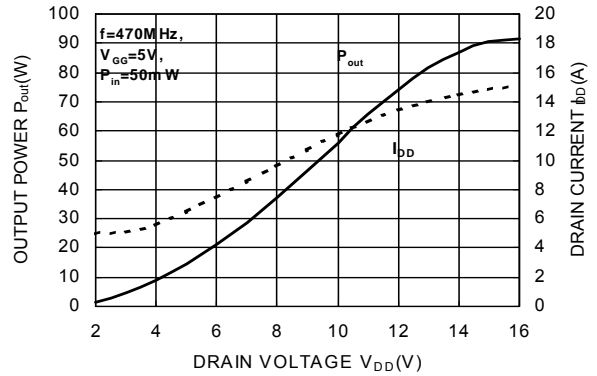

OUTPUT POWER and DRAIN CURRENT versus GATE VOLTAGE

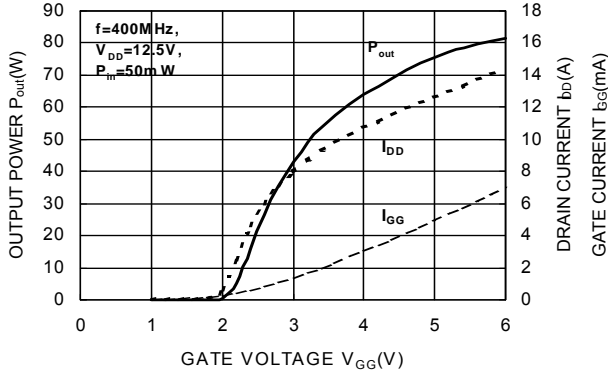

OUTPUT POWER and DRAIN CURRENT versus GATE VOLTAGE

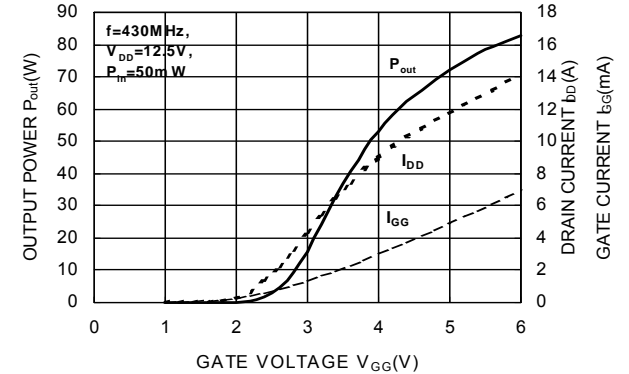

OUTPUT POWER and DRAIN CURRENT versus GATE VOLTAGE

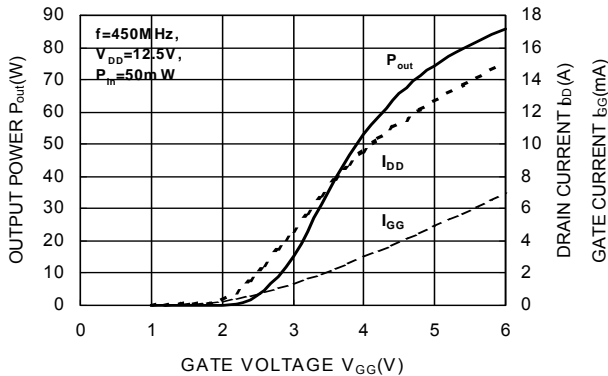

OUTPUT POWER and DRAIN CURRENT versus GATE VOLTAGE

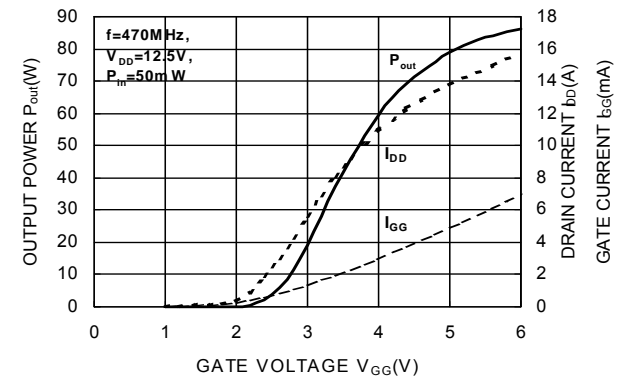



OUTLINE DRAWING (mm)

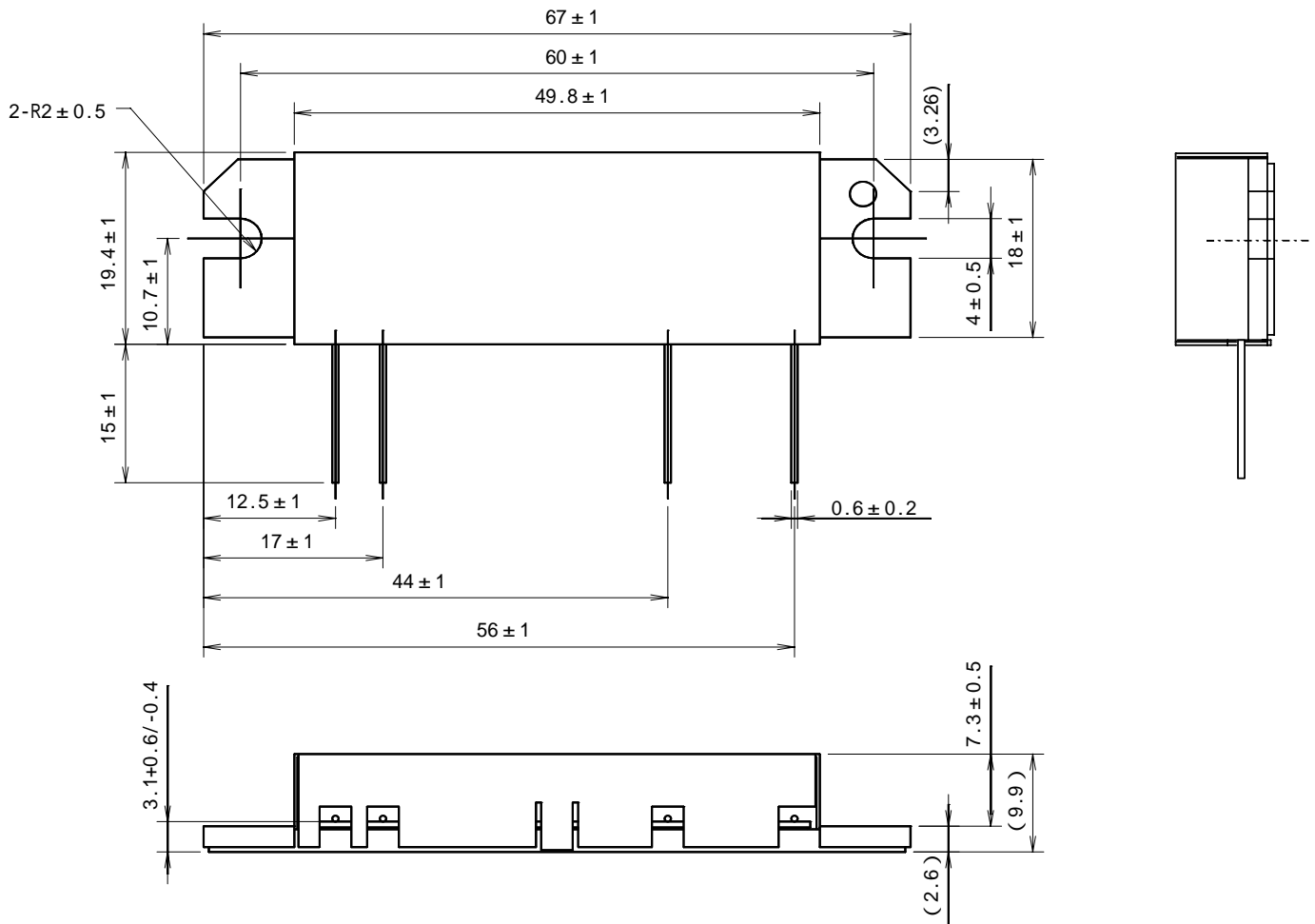

- ① RF Input ( $P_{in}$ )
- ② Gate Voltage ( $V_{GG}$ )
- ③ Drain Voltage ( $V_{DD}$ )
- ④ RF Output ( $P_{out}$ )
- ⑤ RF Ground (Case)





**PRECAUTIONS, RECOMMENDATIONS, and APPLICATION INFORMATION:**

**Construction:**

This module consists of a glass-epoxy substrate soldered onto a copper flange. For mechanical protection, a metal cap is attached (which makes the improvement of RF radiation easy). The MOSFET transistor chips are die bonded onto metal, wire bonded to the substrate, and coated with resin. Lines on the substrate (eventually inductors), chip capacitors, and resistors form the bias and matching circuits. Wire leads soldered onto the glass-epoxy substrate provide the DC and RF connection.

Following conditions must be avoided:

- a) Bending forces on the glass-epoxy substrate (for example, by driving screws or from fast thermal changes)
- b) Mechanical stress on the wire leads (for example, by first soldering then driving screws or by thermal expansion)
- c) Defluxing solvents reacting with the resin coating on the MOSFET chips (for example, Trichloroethylene)
- d) Frequent on/off switching that causes thermal expansion of the resin
- e) ESD, surge, overvoltage in combination with load VSWR, and oscillation

**ESD:**

This MOSFET module is sensitive to ESD voltages down to 1000V. Appropriate ESD precautions are required.

**Mounting:**

A thermal compound between module and heat sink is recommended for low thermal contact resistance and to reduce the bending stress on the glass-epoxy substrate caused by the temperature difference to the heat sink. The module must first be screwed to the heat sink, then the leads can be soldered to the printed circuit board. M3 screws are recommended with a tightening torque of 0.4 to 0.6 Nm.

**Soldering and Defluxing:**

This module is designed for manual soldering.

The leads must be soldered after the module is screwed onto the heat sink.

The temperature of the lead (terminal) soldering should be lower than 350°C and shorter than 3 second.

Ethyl Alcohol is recommend for removing flux. Trichloroethylene solvents must not be used (they may cause bubbles in the coating of the transistor chips which can lift off the bond wires).

**Thermal Design of the Heat Sink:**

At  $P_{out}=60W$ ,  $V_{DD}=12.5V$  and  $P_{in}=50mW$  each stage transistor operating conditions are:

Stage	$P_{in}$ (W)	$P_{out}$ (W)	$R_{th(ch-case)}$ (°C/W)	$I_{DD} @ \eta_T=40\%$ (A)	$V_{DD}$ (V)
1 <sup>st</sup>	0.05	2.5	2.24	1.5	12.5
2 <sup>nd</sup>	2.5	60.0	0.45	10.5	

The channel temperatures of each stage transistor  $T_{ch} = T_{case} + (V_{DD} \times I_{DD} - P_{out} + P_{in}) \times R_{th(ch-case)}$  are:

$$T_{ch1} = T_{case} + (12.5V \times 1.5A - 2.5W + 0.05W) \times 2.24°C/W = T_{case} + 36.5 °C$$

$$T_{ch2} = T_{case} + (12.5V \times 10.5A - 60.0W + 2.5W) \times 0.45°C/W = T_{case} + 33.2 °C$$

For long-term reliability, it is best to keep the module case temperature ( $T_{case}$ ) below 90°C. For an ambient temperature  $T_{air}=60°C$  and  $P_{out}=60W$ , the required thermal resistance  $R_{th(case-air)} = (T_{case} - T_{air}) / ((P_{out} / \eta_T) - P_{out} + P_{in})$  of the heat sink, including the contact resistance, is:

$$R_{th(case-air)} = (90°C - 60°C) / (60W/40\% - 60W + 0.05W) = 0.33 °C/W$$

When mounting the module with the thermal resistance of 0.33 °C/W, the channel temperature of each stage transistor is:

$$T_{ch1} = T_{air} + 66.5 °C$$

$$T_{ch2} = T_{air} + 63.2 °C$$

The 175°C maximum rating for the channel temperature ensures application under derated conditions.



### Output Power Control:

Depending on linearity, the following three methods are recommended to control the output power:

a) Non-linear FM modulation at high power operating:

By the gate voltage ( $V_{GG}$ ).

When the gate voltage is close to zero, the nominal output signal ( $P_{out}=60W$ ) is attenuated up to 60 dB and only a small leakage current flows from the battery into the drain.

Around  $V_{GG}=0V$  (minimum), the output power and drain current increases substantially.

Around  $V_{GG}=4V$  (typical) to  $V_{GG}=5V$  (maximum), the nominal output power becomes available.

b) Linear AM modulation:

By RF input power  $P_{in}$ .

The gate voltage is used to set the drain's quiescent current for the required linearity.

### Oscillation:

To test RF characteristics, this module is put on a fixture with two bias decoupling capacitors each on gate and drain, a 4.700 pF chip capacitor, located close to the module, and a 22  $\mu F$  (or more) electrolytic capacitor.

When an amplifier circuit around this module shows oscillation, the following may be checked:

a) Do the bias decoupling capacitors have a low inductance pass to the case of the module?

b) Is the load impedance  $Z_L=50\Omega$ ?

c) Is the source impedance  $Z_G=50\Omega$ ?

### Frequent on/off switching:

In base stations, frequent on/off switching can cause thermal expansion of the resin that coats the transistor chips and can result in reduced or no output power. The bond wires in the resin will break after long-term thermally induced mechanical stress.

### Quality:

Mitsubishi Electric is not liable for failures resulting from base station operation time or operating conditions exceeding those of mobile radios.

This module technology results from more than 20 years of experience, field proven in tens of millions of mobile radios. Currently, most returned modules show failures such as ESD, substrate crack, and transistor burnout, which are caused by improper handling or exceeding recommended operating conditions. Few degradation failures are found.

**Keep safety first in your circuit designs!**

Mitsubishi Electric Corporation puts the maximum effort into making semiconductor products better and more reliable, but there is always the possibility that trouble may occur. Trouble with semiconductors may lead to personal injury, fire or property damage. Remember to give due consideration to safety when making your circuit designs, with appropriate measures such as (i) placement of substitutive, auxiliary circuits, (ii) use of non-flammable material, or (iii) prevention against any malfunction or mishap.



---

## SALES CONTACT

### JAPAN:

Mitsubishi Electric Corporation  
Semiconductor Sales Promotion Department  
2-2-3 Marunouchi, Chiyoda-ku  
Tokyo, Japan 100  
Email: sod.sophp@hq.melco.co.jp  
Phone: +81-3-3218-4854  
Fax: +81-3-3218-4861

### HONG KONG:

Mitsubishi Electric Hong Kong Ltd.  
Semiconductor Division  
41/F. Manulife Tower, 169 Electric Road  
North Point, Hong Kong  
Email: scdinfo@mehk.com  
Phone: +852 2510-0555  
Fax: +852 2510-9822

### SINGAPORE:

Mitsubishi Electric Asia PTE Ltd  
Semiconductor Division  
307 Alexandra Road  
#3-01/02 Mitsubishi Electric Building,  
Singapore 159943  
Email: semicon@asia.meap.com  
Phone: +65 64 732 308  
Fax: +65 64 738 984

### TAIWAN:

Mitsubishi Electric Taiwan Company, Ltd.,  
Semiconductor Department  
9F, No. 88, Sec. 6  
Chung Shan N. Road  
Taipei, Taiwan, R.O.C.  
Email: metwnssi@metwn.meap.com  
Phone: +886-2-2836-5288  
Fax: +886-2-2833-9793

### U.S.A.:

Mitsubishi Electric & Electronics USA, Inc.  
Electronic Device Group  
1050 East Arques Avenue  
Sunnyvale, CA 94085  
Email: customerservice@edg.meap.com  
Phone: 408-730-5900  
Fax: 408-737-1129

### CANADA:

Mitsubishi Electric Sales Canada, Inc.  
4299 14th Avenue  
Markham, Ontario, Canada L3R OJ2  
Phone: 905-475-7728  
Fax: 905-475-1918

### GERMANY:

Mitsubishi Electric Europe B.V.  
Semiconductor  
Gothaer Strasse 8  
D-40880 Ratingen, Germany  
Email: semis.info@meg.mee.com  
Phone: +49-2102-486-0  
Fax: +49-2102-486-4140

### FRANCE:

Mitsubishi Electric Europe B.V.  
Semiconductor  
25 Boulevard des Bouvets  
F-92741 Nanterre Cedex, France  
Email: semis.info@meg.mee.com  
Phone: +33-1-55685-668  
Fax: +33-1-55685-739

### ITALY:

Mitsubishi Electric Europe B.V.  
Semiconductor  
Centro Direzionale Colleoni,  
Palazzo Perseo 2, Via Paracelso  
I-20041 Agrate Brianza, Milano, Italy  
Email: semis.info@meg.mee.com  
Phone: +39-039-6053-10  
Fax: +39-039-6053-212

### U.K.:

Mitsubishi Electric Europe B.V.  
Semiconductor  
Travellers Lane, Hatfield  
Hertfordshire, AL10 8XB, England  
Email: semis.info@meuk.mee.com  
Phone: +44-1707-278-900  
Fax: +44-1707-278-837

### AUSTRALIA:

Mitsubishi Electric Australia,  
Semiconductor Division  
348 Victoria Road  
Rydalmere, NSW 2116  
Sydney, Australia  
Email: semis@meaust.meap.com  
Phone: +61 2 9684-7210  
+61 2 9684 7212  
+61 2 9684 7214  
+61 3 9262 9898  
Fax: +61 2 9684-7208  
+61 2 9684 7245