

0.75W isolated DC-DC converter  
Fixed input voltage, regulated single output



EN 62368-1 BS EN 62368-1

Patent Protection  
UK  
CA  
RoHS



## FEATURES

- Continuous short-circuit protection
- No-load input current as low as 5mA
- Operating ambient temperature range: -40°C to +85°C
- High efficiency up to 74%
- Compact SMD package
- I/O isolation test voltage 1.5k VDC
- Industry standard pin-out

IB05\_XT-W75R3 series is especially designed for distributed power supply systems where an isolated voltage is required. They are particularly suitable for applications of : pure digital circuits, general low frequency analog circuits, relay-driven circuits and data switching circuits.

## Selection Guide

Certification	Part No.	Input Voltage (VDC)	Output		Full Load Efficiency(%) Min./Typ.	Capacitive Load ( $\mu$ F) Max.
		Nominal (Range)	Voltage (VDC)	Current (mA) Max./Min.		
EN/BS EN	IB0503XT-W75R3	5 (4.75-5.25)	3.3	200/20	64/68	2400
	IB0505XT-W75R3		5	150/15	68/72	2400
	IB0509XT-W75R3		9	83/9	68/72	1000
	IB0512XT-W75R3		12	62/7	69/73	560
	IB0515XT-W75R3		15	50/5	70/74	560

## Input Specifications

Item	Operating Conditions	Min.	Typ.	Max.	Unit	
Input Current (full load / no-load)	5VDC input	3.3VDC/5VDC output	--	221/5	234/10	mA
		9VDC/12VDC output	--	208/12	221/20	
		15VDC output	--	202/18	215/30	
Reflected Ripple Current*		--	15	--	mA	
Input Filter		Capacitance Filter				
Hot Plug		Unavailable				

Note: \* Refer to DC-DC Converter Application Notes for detailed description of reflected ripple current test method.

## Output Specifications

Item	Operating Conditions	Min.	Typ.	Max.	Unit
Voltage Accuracy		--	--	$\pm 3$	%
Linear Regulation	Input voltage change: $\pm 1\%$	--	--	$\pm 0.25$	
Load Regulation	10%-100% load	3.3VDC output	--	$\pm 3$	
		Others	--	$\pm 2$	
Ripple & Noise*	20MHz bandwidth	--	30	75	mVp-p
Temperature Coefficient	100% load	--	$\pm 0.02$	--	%/°C
Short-circuit Protection		Continuous, self-recovery			

Note: \* The "parallel cable" method is used for Ripple and Noise test, please refer to DC-DC Converter Application Notes for specific information.

General Specifications

Item	Operating Conditions	Min.	Typ.	Max.	Unit
Isolation	Input-output Electric Strength Test for 1 minute with a leakage current of 1mA max.	1500	--	--	VDC
	Input-output Electric Strength Test for 1 second with a leakage current of 1mA max.	3000	--	--	
Insulation Resistance	Input-output resistance at 500VDC	1000	--	--	MΩ
Isolation Capacitance	Input-output capacitance at 100kHz/0.1V	--	20	--	pF
Operating Temperature	Derating when operating temperature $\geq 71^{\circ}\text{C}$ , (see Fig. 1)	-40	--	85	°C
Storage Temperature		-55	--	125	
Case Temperature Rise	Ta =25°C	3.3VDC output	--	30	
		Others	--	25	--
Reflow Soldering Temperature*		Peak temp. $\leq 245^{\circ}\text{C}$ , maximum duration time $\leq 60\text{s}$ over $217^{\circ}\text{C}$			
Storage Humidity	Non-condensing	--	--	95	%RH
Switching Frequency	100% load, nominal input voltage	--	270	--	kHz
MTBF	MIL-HDBK-217F@25°C	3500	--	--	k hours
Moisture Sensitivity Level (MSL)	IPC/JEDEC J-STD-020D.1	Level 1			

Note: \* Please also refer to IPC/JEDEC J-STD-020D.1 for additional information.

Mechanical Specifications

Case Material	Black plastic; flame-retardant and heat-resistant (UL94 V-0)
Dimensions	13.20 x 11.40 x 7.25mm
Weight	1.4g(Typ.)
Cooling Method	Free air convection

Electromagnetic Compatibility (EMC)

Emissions	CE	CISPR32/EN55032	CLASS B (see Fig. 3 for recommended circuit)
	RE	CISPR32/EN55032	CLASS B (see Fig. 3 for recommended circuit)
Immunity	ESD	IEC/EN61000-4-2	Air $\pm 8\text{kV}$ , Contact $\pm 4\text{kV}$ perf. Criteria B

Typical Characteristic Curves

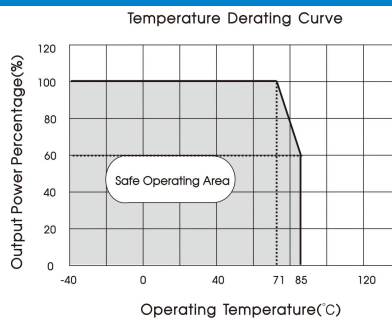
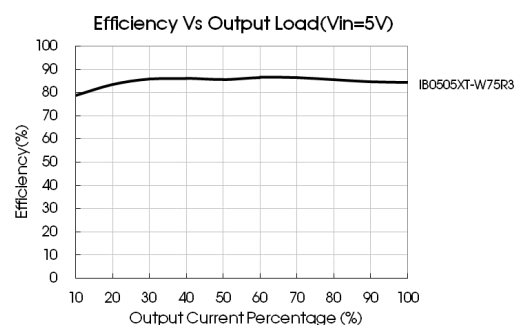
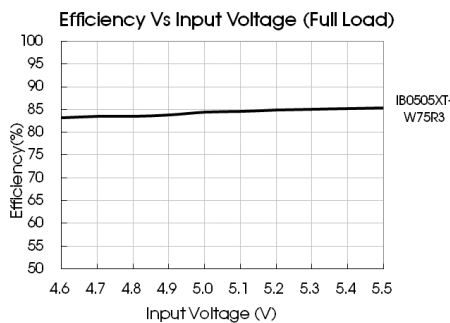

Fig. 1



Design Reference

1. Typical application

Input and/or output ripple can be further reduced, by connecting a filter capacitor from the input and/or output terminals to ground as shown in Fig. 2.

Choosing suitable filter capacitor values is very important for a smooth operation of the modules, particularly to avoid start-up problems caused by capacitor values that are too high. For recommended input and output capacitor values refer to Table 1.

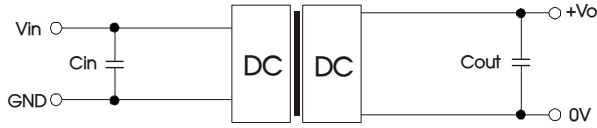

Fig. 2

Table 1: Recommended input and output capacitor values

Vin	Cin	Vo	Cout
5VDC	4.7μF/16V	3.3/5VDC	10μF/16V
		9/12VDC	2.2μF/16V
		15VDC	1μF/25V

2. EMC compliance circuit

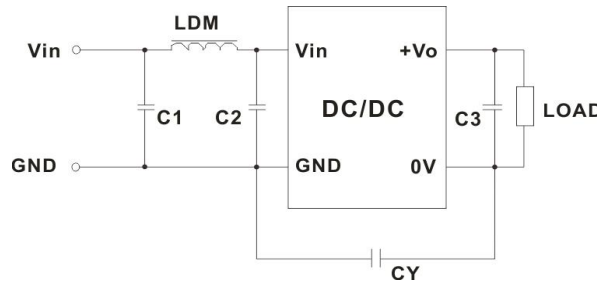

Fig. 3

Table 2: Recommended EMC filter values

Input voltage 5VDC	Output voltage		3.3/5/9VDC	12/15VDC
	Emissions	C1/C2	4.7μF /25V	4.7μF /25V
		CY	--	1nF /2kVDC HEC C1206X102K202T JOHANSON 202R18W102KV4E
		C3	Refer to the Cout in table 1	
		LDM	6.8μH	6.8μH

Note: We recommend the use of a Y-capacitor CY with a value of 1nF/4kV to help even further reduce emissions.

3. For additional information please refer to DC-DC converter application notes on [www.mornsun-power.com](http://www.mornsun-power.com)

Dimensions and Recommended Layout

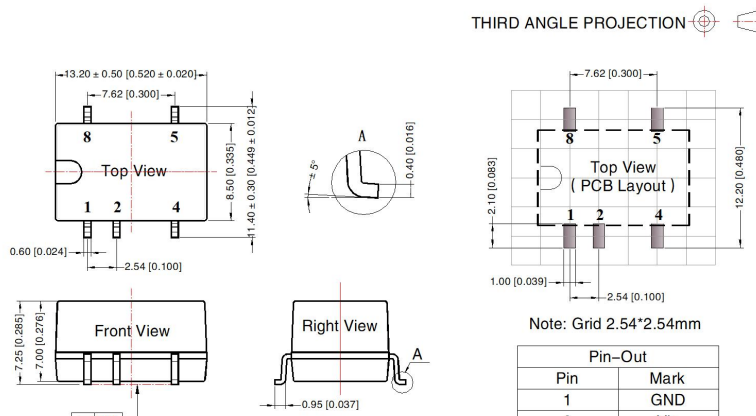

Note:  
Unit: mm[inch]  
Pin section tolerances: ± 0.10 [± 0.004]  
General tolerances: ± 0.25 [± 0.010]

THIRD ANGLE PROJECTION

Note: Grid 2.54\*2.54mm

Pin-Out	
Pin	Mark
1	GND
2	Vin
4	0V
5	+Vo
8	NC

NC: Pin to be isolated from circuitry

Tape and Reel Info

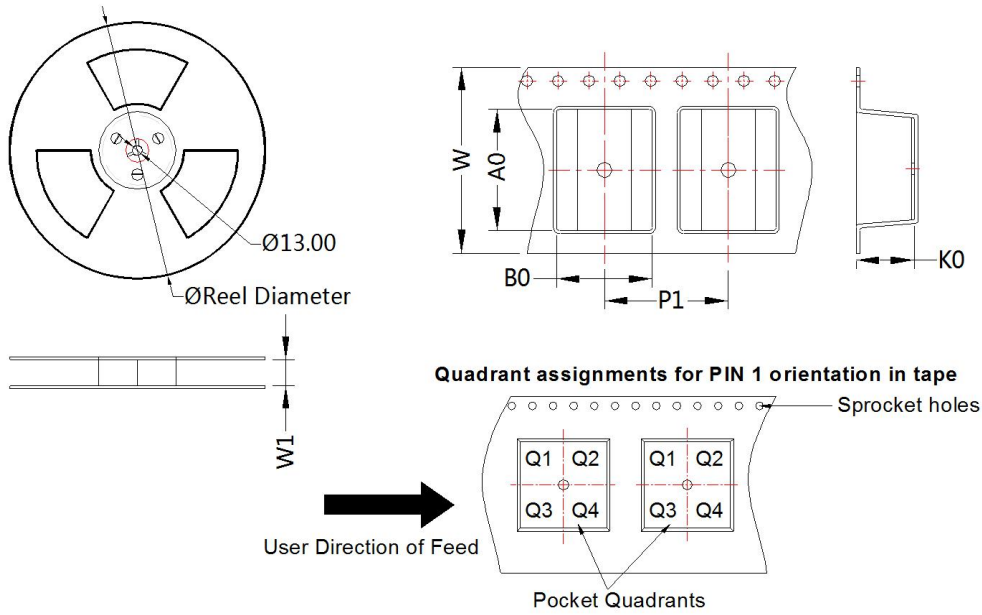

Device	Package Type	Pin	SPQ	Reel Diameter (mm)	Reel Width W1 (mm)	A0 (mm)	B0 (mm)	K0 (mm)	P1 (mm)	W (mm)	Pin1 Quadrant
IB05_XT-W75R3	SMD	5	500	330.0	24.5	13.4	11.7	7.5	16.0	24.0	Q1

Notes:

1. For additional information on Product Packaging please refer to [www.mornsun-power.com](http://www.mornsun-power.com). Tube Packaging bag number: 58210024, Roll Packaging bag number: 58200054;
2. If the product is not operated within the required load range, the product performance cannot be guaranteed to comply with all parameters in the datasheet;
3. The maximum capacitive load offered were tested at input voltage range and full load;
4. Unless otherwise specified, parameters in this datasheet were measured under the conditions of Ta=25°C, humidity<75%RH with nominal input voltage and rated output load;
5. All index testing methods in this datasheet are based on our company corporate standards;
6. We can provide product customization service, please contact our technicians directly for specific information;
7. Products are related to laws and regulations: see "Features" and "EMC";
8. Our products shall be classified according to ISO14001 and related environmental laws and regulations, and shall be handled by qualified units.

MORNSUN Guangzhou Science & Technology Co., Ltd.

Address: No. 5, Kehui St. 1, Kehui Development Center, Science Ave., Guangzhou Science City, Huangpu District, Guangzhou, P. R. China  
Tel: 86-20-38601850 Fax: 86-20-38601272 E-mail: [info@mornsun.cn](mailto:info@mornsun.cn) [www.mornsun-power.com](http://www.mornsun-power.com)