

High Voltage Standard Rectifier

$$V_{RRM} = 2200V$$

$$I_{FAV} = 30A$$

$$V_F = 1.22V$$

Single Diode

Part number

DNA30E2200FE

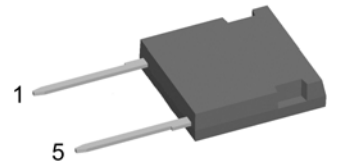

Backside: isolated

 E72873

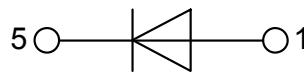

Features / Advantages:

- Planar passivated chips
- Very low leakage current
- Very low forward voltage drop
- Improved thermal behaviour

Applications:

- Diode for main rectification
- For single and three phase bridge configurations

Package: i4-Pac

- Isolation Voltage: 3000 V~
- Industry convenient outline
- RoHS compliant
- Epoxy meets UL 94V-0
- Soldering pins for PCB mounting
- Backside: DCB ceramic
- Reduced weight
- Advanced power cycling

Rectifier				Ratings			
Symbol	Definition	Conditions		min.	typ.	max.	Unit
V_{RSM}	max. non-repetitive reverse blocking voltage					2300	V
V_{RRM}	max. repetitive reverse blocking voltage					2200	V
I_R	reverse current	$V_R = 2200$ V	$T_{VJ} = 25^\circ\text{C}$			40	μA
		$V_R = 2200$ V	$T_{VJ} = 150^\circ\text{C}$			1.5	mA
V_F	forward voltage drop	$I_F = 30$ A	$T_{VJ} = 25^\circ\text{C}$			1.25	V
		$I_F = 60$ A				1.50	V
		$I_F = 30$ A	$T_{VJ} = 150^\circ\text{C}$			1.22	V
		$I_F = 60$ A				1.59	V
I_{FAV}	average forward current	$T_C = 110^\circ\text{C}$ rectangular	$T_{VJ} = 175^\circ\text{C}$ d = 0.5			30	A
V_{FO}	threshold voltage	} for power loss calculation only				0.83	V
r_F	slope resistance						12.8
R_{thJC}	thermal resistance junction to case					1.35	K/W
R_{thCH}	thermal resistance case to heatsink				0.20		K/W
P_{tot}	total power dissipation			$T_C = 25^\circ\text{C}$		110	W
I_{FSM}	max. forward surge current	t = 10 ms; (50 Hz), sine	$T_{VJ} = 45^\circ\text{C}$			370	A
		t = 8,3 ms; (60 Hz), sine	$V_R = 0$ V			400	A
		t = 10 ms; (50 Hz), sine	$T_{VJ} = 150^\circ\text{C}$			315	A
		t = 8,3 ms; (60 Hz), sine	$V_R = 0$ V			340	A
I^2t	value for fusing	t = 10 ms; (50 Hz), sine	$T_{VJ} = 45^\circ\text{C}$			685	A ² s
		t = 8,3 ms; (60 Hz), sine	$V_R = 0$ V			665	A ² s
		t = 10 ms; (50 Hz), sine	$T_{VJ} = 150^\circ\text{C}$			495	A ² s
		t = 8,3 ms; (60 Hz), sine	$V_R = 0$ V			480	A ² s
C_J	junction capacitance	$V_R = 700$ V; f = 1 MHz		$T_{VJ} = 25^\circ\text{C}$		7	pF

Package i4-Pac			Ratings			
Symbol	Definition	Conditions	min.	typ.	max.	Unit
I_{RMS}	RMS current	per terminal			70	A
T_{VJ}	virtual junction temperature		-55		175	°C
T_{op}	operation temperature		-55		150	°C
T_{stg}	storage temperature		-55		150	°C
Weight				9		g
F_C	mounting force with clip		20		120	N
$d_{Spp/App}$	creepage distance on surface striking distance through air	terminal to terminal	13.8			mm
$d_{Spb/Appb}$		terminal to backside	5.1			mm
V_{ISOL}	isolation voltage	t = 1 second	3000			V
		t = 1 minute	2500			V

Product Marking

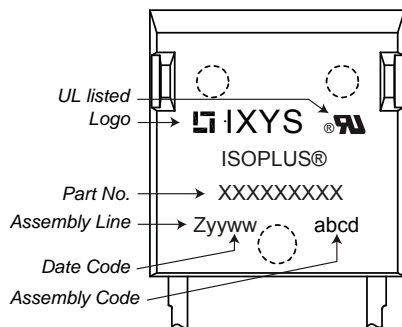

Part number

- D = Diode
- N = High Voltage Standard Rectifier
- A = ($\geq 2000V$)
- 30 = Current Rating [A]
- E = Single Diode
- 2200 = Reverse Voltage [V]
- FE = i4-Pac (2HV)

Ordering	Part Number	Marking on Product	Delivery Mode	Quantity	Code No.
Standard	DNA30E2200FE	DNA30E2200FE	Tube	25	508861

Similar Part	Package	Voltage class
DNA30E2200PA	TO-220AC	2200
DNA30E2200PZ	TO-263AB (D2Pak) (2HV)	2200
DNA30EM2200PZ	TO-263AB (D2Pak) (2HV)	2200
DNA30E2200IY	TO-262 (2HV) (I2PAK)	2200

Equivalent Circuits for Simulation

* on die level

$T_{VJ} = 175^\circ C$

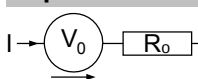

Rectifier

$V_{0\ max}$	threshold voltage	0.83	V
$R_{0\ max}$	slope resistance *	10.2	mΩ

Outlines i4-Pac

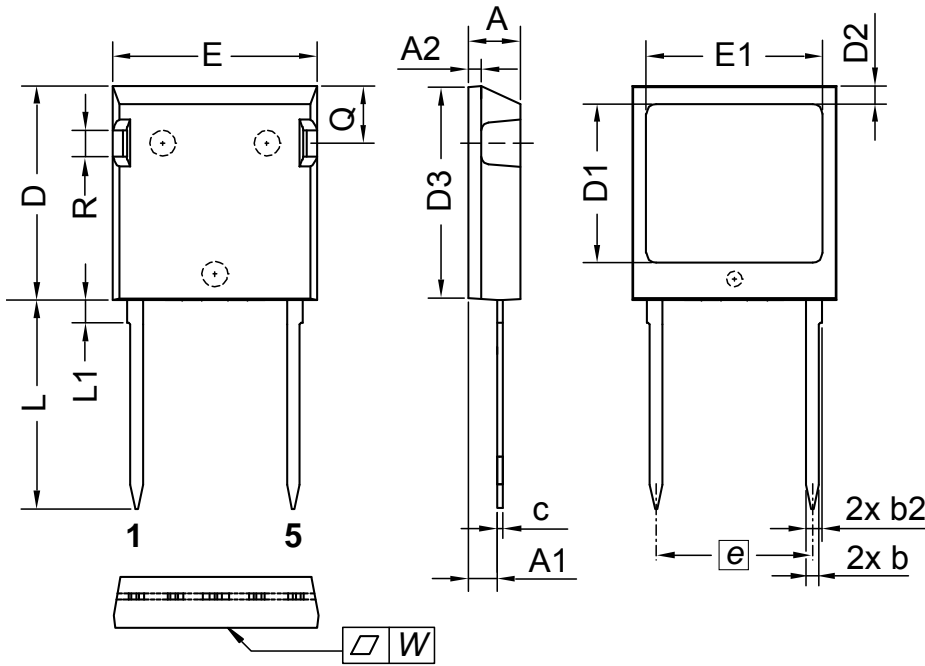

Dim.	Millimeter		Inches	
	min	max	min	max
A	4.83	5.21	0.190	0.205
A1	2.59	3.00	0.102	0.118
A2	1.17	2.16	0.046	0.085
b	1.14	1.40	0.045	0.055
b2	1.47	1.73	0.058	0.068
c	0.51	0.74	0.020	0.029
D	20.80	21.34	0.819	0.840
D1	14.99	15.75	0.590	0.620
D2	1.65	2.03	0.065	0.080
D3	20.30	20.70	0.799	0.815
E	19.56	20.29	0.770	0.799
E1	16.76	17.53	0.660	0.690
e	15.24	BSC	0.600	BSC
L	19.81	21.34	0.780	0.840
L1	2.11	2.59	0.083	0.102
Q	5.33	6.20	0.210	0.244
R	2.54	4.57	0.100	0.180
W	-	0.10	-	0.004

Die konvexe Form des Substrates ist typ. < 0.05 mm über der Kunststoffoberfläche der Bauteilunterseite
 The convexbow of substrate is typ. < 0.05 mm over plastic surface level of device bottom side

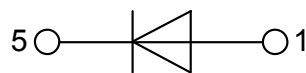

Rectifier

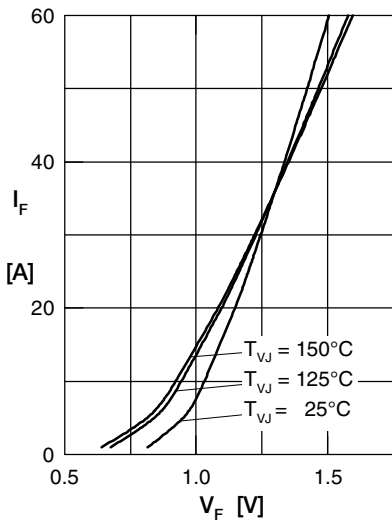

Fig. 1 Forward current versus voltage drop per diode

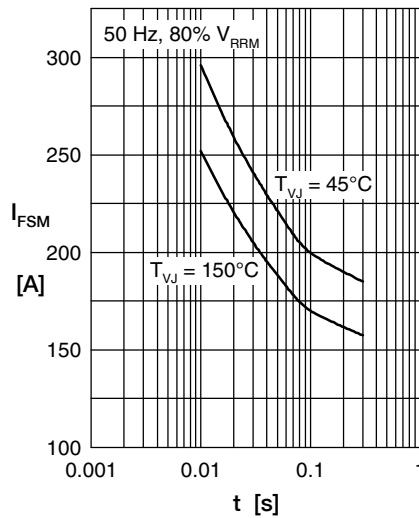

Fig. 2 Surge overload current

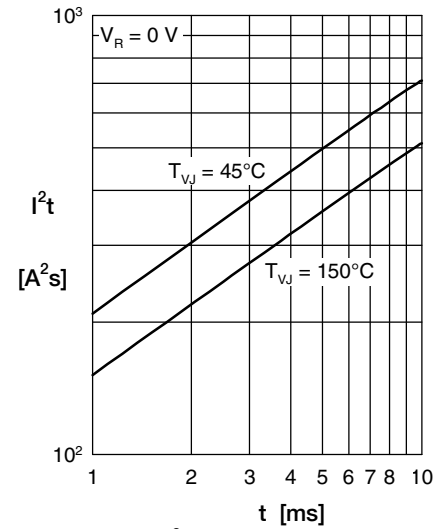

Fig. 3 I^2t versus time per diode

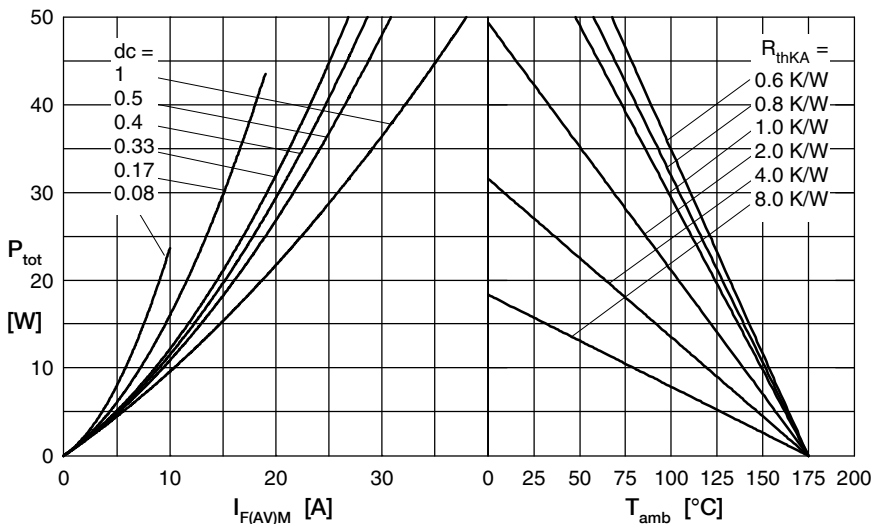

Fig. 4 Power dissipation versus direct output current & ambient temperature

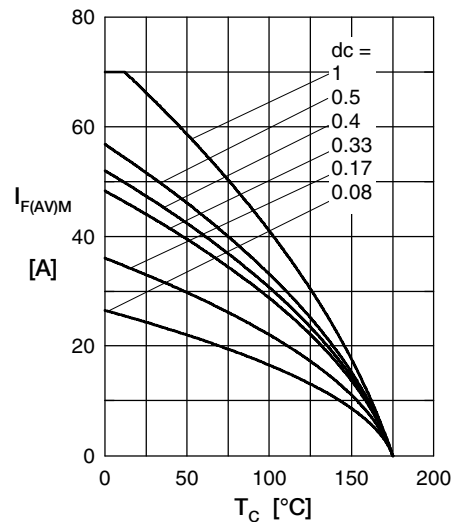

Fig. 5 Max. forward current versus case temperature

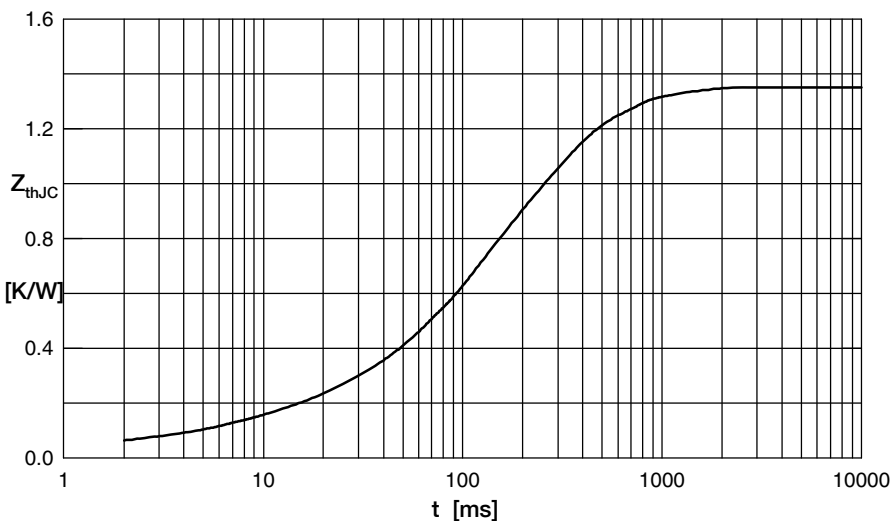

Fig. 6 Transient thermal impedance junction to case

Constants for Z_{thJC} calculation:

i	R_{thi} (K/W)	t_i (s)
1	0.03	0.0003
2	0.072	0.0065
3	0.122	0.083
4	0.736	0.152
5	0.39	0.4

Mouser Electronics

Authorized Distributor

Click to View Pricing, Inventory, Delivery & Lifecycle Information:

[IXYS:](#)

[DNA30E2200FE](#)