



Application Notes: SY8366H

High Efficiency Fast Response 6A Continuous, 12A Peak, 28V Input Synchronous Step Down Regulator

General Description

The SY8366H develops a high efficiency synchronous step-down DC-DC regulator capable of delivering 6A continuous, 12A peak current. The SY8366H operates over a wide input voltage range from 4V to 28V and integrates main switch and synchronous switch with very low $R_{DS(ON)}$ to minimize the conduction loss.

The SY8366H adopts the instant PWM architecture to achieve fast transient responses for high step down applications and high efficiency at light loads. In addition, it operates at pseudo-constant frequency of 800kHz under continuous conduction mode to minimize the size of inductor and capacitor.

Ordering Information

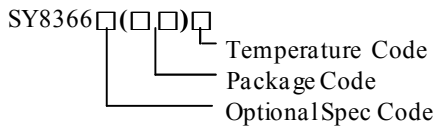

Ordering Number	Package type	Note
SY8366HQQC	QFN3x3-12	--

Features

- Low $R_{DS(ON)}$ for internal switches (top/bottom): 40/20 m Ω
- Wide input voltage range: 4-28V
- Instant PWM architecture to achieve fast transient responses
- Internal 600us softstart limits the inrush current
- Pseudo-constant frequency: 800kHz.
- 6A continuous/12A peak output current capability
- $\pm 1.5\%$ 0.6V reference
- Programmable peak current limit
- Power good indicator
- Output discharge function
- Hic-cup mode output short circuit protection
- Input UVLO
- Over temperature protection
- RoHS Compliant and Halogen Free
- Compact package: QFN3x3-12

Applications

- LCD-TV/Net-TV/3DTV
- Set Top Box
- Notebook
- High Power AP

Typical Applications

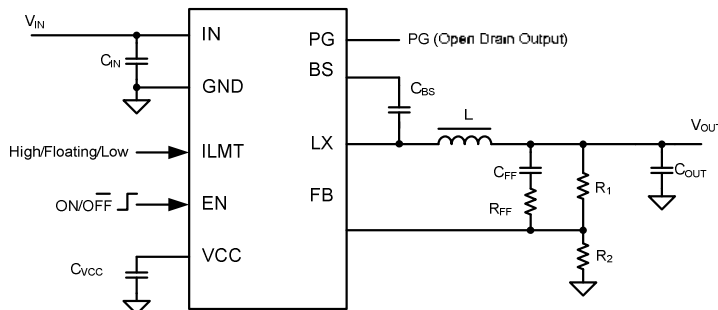

Figure 1 Schematic

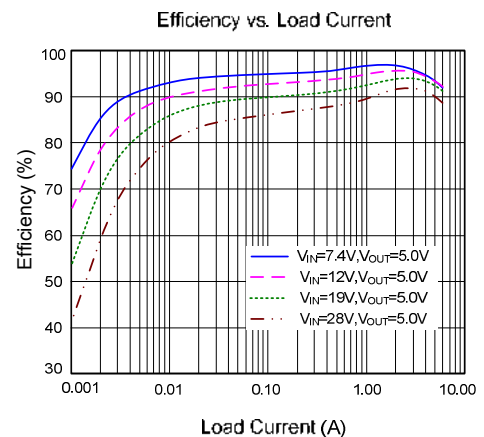
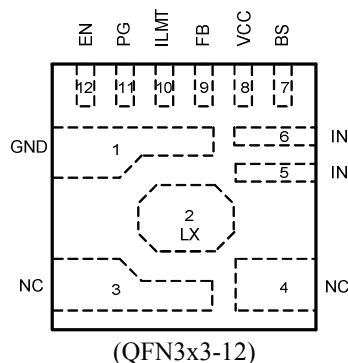

Figure 2. Efficiency

Pinout (top view)



Top Mark: BAF_{xyz}, (Device code: BAF, x=*year code*, y=*week code*, z=*lot number code*)

Pin Name	Pin Number	Pin Description
GND	1	Ground pin
LX	2	Inductor pin. Connect this pin to the switching node of inductor
IN	5, 6	Input pin. Decouple this pin to GND pin with at least 10uF ceramic cap
BS	7	Boot-Strap Pin. Supply high side gate driver. Decouple this pin to LX pin with 0.1uF ceramic cap.
VCC	8	Internal 3.3V LDO output. Power supply for internal analog circuits and driving circuit. Decouple this pin to GND with a 2.2uF MLCC.
FB	9	Output Feedback Pin. Connect this pin to the center point of the output resistor divider (as shown in Figure 1) to program the output voltage: $V_{out}=0.6*(1+R1/R2)$
ILMT	10	Current limit setting pin. The current limit is set to 6A, 9A or 12A when this pin is pull low, floating or pull high respectively.
PG	11	Power good Indicator. Open drain output when the output voltage is within 90% to 120% of regulation point.
EN	12	Enable control. Pull this pin high to turn on the IC. Do not leave this pin floating.

Absolute Maximum Ratings (Note 1)

IN, LX, PG, EN	-----	30V
BS-LX, FB, ILMT, VCC	-----	4V
Power Dissipation, PD @ T _A = 25°C QFN3x3-12	-----	3.3W
Package Thermal Resistance (Note 2)		
θ _{JA}	-----	30°C/W
θ _{JC}	-----	4°C/W
Junction Temperature Range	-----	150°C
Lead Temperature (Soldering, 10 sec.)	-----	260°C
Storage Temperature Range	-----	-65°C to 150°C
Dynamic LX voltage in 10ns duration	-----	IN+3V to GND-5V

Recommended Operating Conditions (Note 3)

Supply Input Voltage	-----	4V to 28V
Junction Temperature Range	-----	-40°C to 150°C
Ambient Temperature Range	-----	-40°C to 85°C

Block Diagram

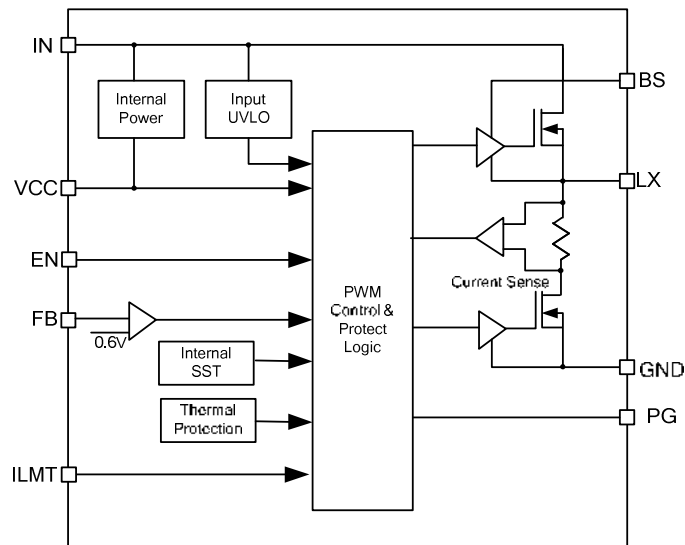



Electrical Characteristics

($V_{IN} = 12V$, $V_{OUT} = 5V$, $C_{OUT} = 100\mu F$, $T_A = 25^\circ C$, $I_{OUT} = 2A$ unless otherwise specified)

Parameter	Symbol	Test Conditions	Min	Typ	Max	Unit
Input Voltage Range	V_{IN}		4.0		28	V
Quiescent Current	I_Q	$I_{OUT} = 0$, $V_{FB} = V_{REF} * 105\%$		100		μA
Shutdown Current	I_{SHDN}	EN=0		3	10	μA
Feedback Reference Voltage	V_{REF}		0.591	0.6	0.609	V
FB Input Current	I_{FB}	$V_{FB} = 4V$	-50		50	nA
Top FET RON	$R_{ds(on)1}$			40		$m\Omega$
Bottom FET RON	$R_{ds(on)2}$			20		$m\Omega$
Discharge Current	I_{DIS}			100		mA
Bottom FET Current Limit	I_{LIM}	ILMT='0'	6			A
		ILMT=Floating	9			
		ILMT='1'	12			
ILMT Rising Threshold	V_{ILMTH}		$V_{CC} - 0.8$		V_{CC}	V
ILMT Falling Threshold	V_{ILMTL}				0.8	V
ILMT Floating Threshold	V_{ILMIF}		1.3		2	V
Soft Start Time	T_{SS}			600		μs
EN Rising Threshold	V_{ENH}		0.8			V
EN Falling Threshold	V_{ENL}				0.4	V
EN Leakage Current	I_{EN}		-1		1	μA
Input UVLO Threshold	V_{UVLO}				3.9	V
UVLO hysteresis	V_{HYS}			0.3		V
Oscillator Frequency	F_{OSC}	$V_O = 5V$	0.68	0.8	0.92	MHz
Min ON Time	$T_{ON,MIN}$	$V_{IN} = V_{IN,MAX}$		50		ns
Min OFF Time	$T_{OFF,MIN}$			180		ns
VCC Output	V_{CC}	$V_{IN} = 4V$	3.2	3.3	3.4	V
Output Over Voltage Threshold		V_{FB} Rising	115	120	125	$\%V_{REF}$
Output Over Voltage Hysteresis				2		$\%V_{REF}$
Output Over Voltage Delay Time				20		μs
Power Good Threshold		V_{FB} Rising	88	90	92	$\%V_{REF}$
Power Good Hysteresis				2		$\%V_{REF}$
Power Good Delay Time				10		μs
Thermal Shutdown Temperature	T_{SD}			150		$^\circ C$
Thermal Shutdown hysteresis	T_{HYS}			15		$^\circ C$

Note 1: Stresses beyond the “Absolute Maximum Ratings” may cause permanent damage to the device. These are stress ratings only. Functional operation of the device at these or any other conditions beyond those indicated in the operational sections of the specification is not implied. Exposure to absolute maximum rating conditions for extended periods may affect device reliability

Note 2: θ_{JA} is measured in the natural convection at $T_A = 25^\circ C$ on a four-layer Silergy Evaluation Board..

Note 3: The device is not guaranteed to function outside its operating conditions.

Typical Performance Characteristics

Efficiency vs. Load Current

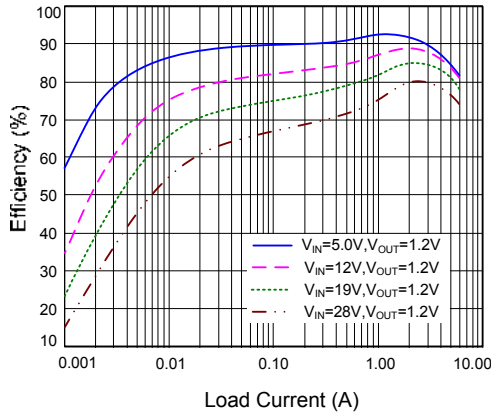

Efficiency vs. Load Current

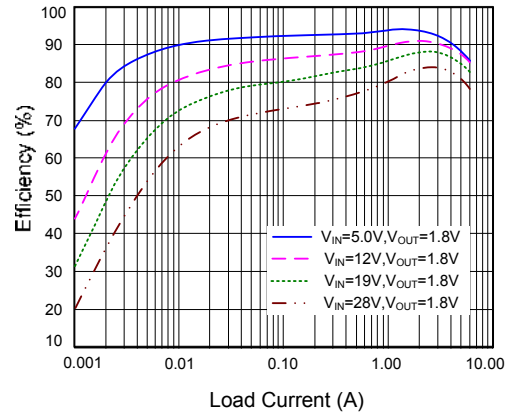

Efficiency vs. Load Current

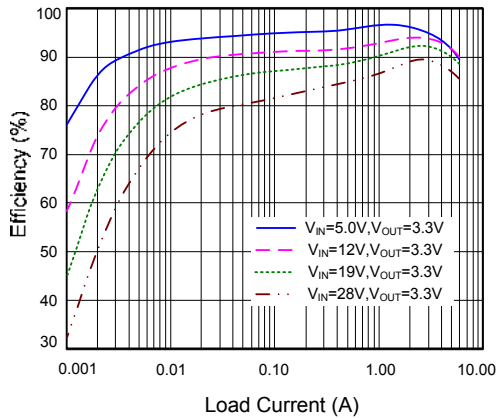

Efficiency vs. Load Current

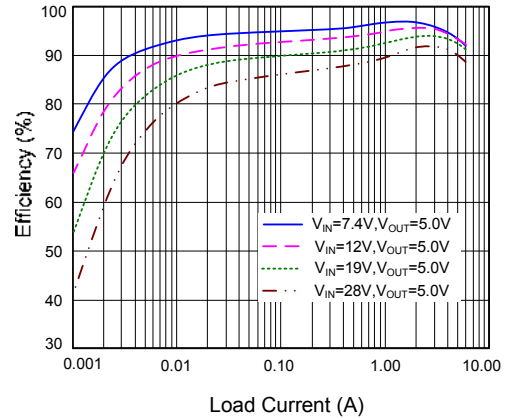

Load Transient

($V_{IN}=12V, V_{OUT}=5V, I_{LOAD}=0\sim 3A$)

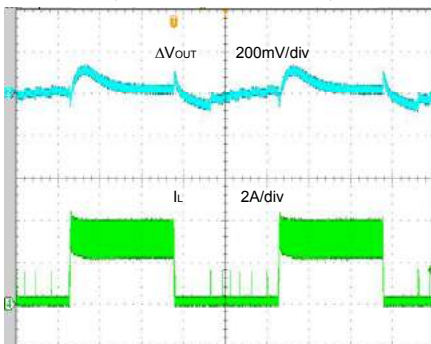

Time (200 μ s/div)

Load Transient

($V_{IN}=12V, V_{OUT}=5V, I_{LOAD}=0.6\sim 6A$)

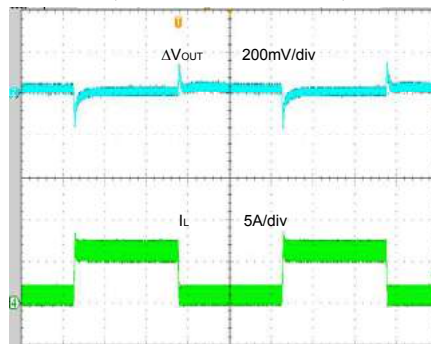

Time (200 μ s/div)



SY8366H

Startup from Enable
($V_{IN}=12V$, $V_{OUT}=5V$, $I_{LOAD}=6A$)

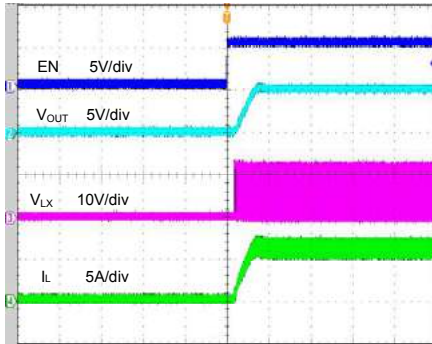

Time (800µs/div)

Shutdown from Enable
($V_{IN}=12V$, $V_{OUT}=5V$, $I_{LOAD}=6A$)

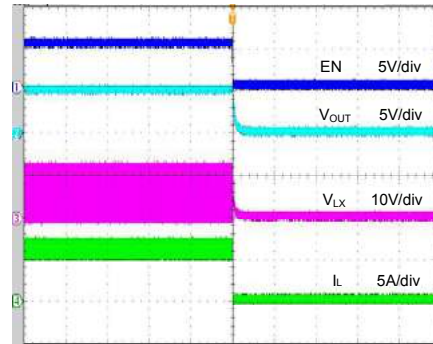

Time (800µs/div)

Startup from VIN
($V_{IN}=12V$, $V_{OUT}=5V$, $I_{LOAD}=6A$)

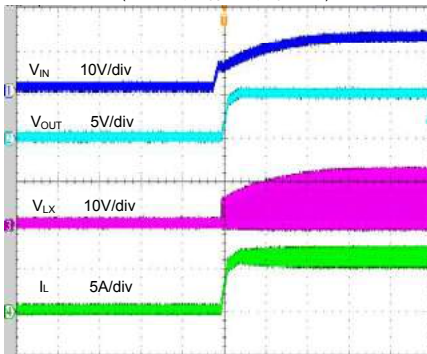

Time (2ms/div)

Shutdown from VIN
($V_{IN}=12V$, $V_{OUT}=5V$, $I_{LOAD}=6A$)

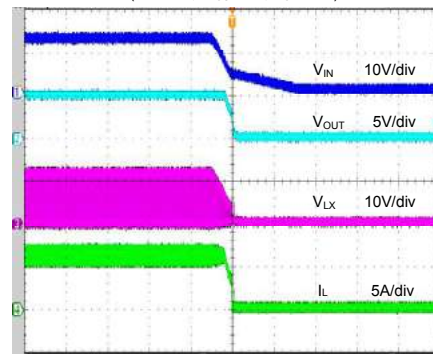

Time (2ms/div)

Short Circuit Protection
($V_{in}=12V$, $V_o=5V$, 0A to short)

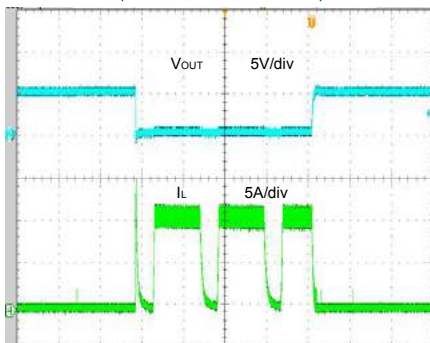

Time (800µs/div)

Short Circuit Protection
($V_{in}=12V$, $V_o=5V$, 6A to short)

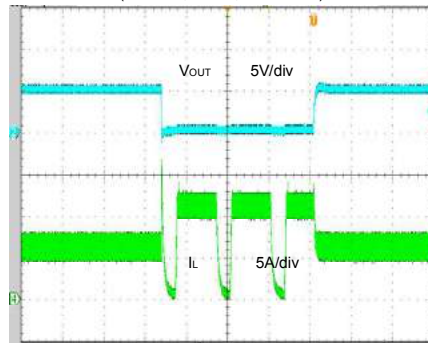

Time (800µs/div)

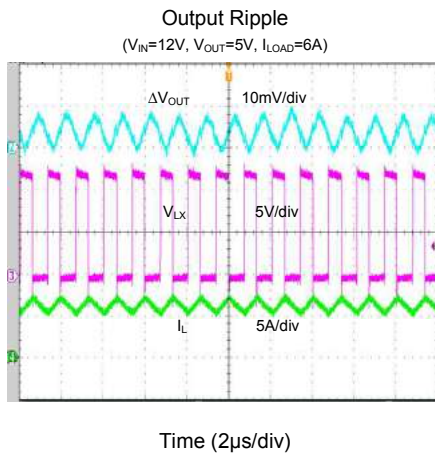

Operation

The SY8366H develops a high efficiency synchronous step-down DC-DC regulator capable of delivering 6A continuous, 12A peak current. The SY8366H operates over a wide input voltage range from 4V to 28V and integrates main switch and synchronous switch with very low $R_{DS(ON)}$ to minimize the conduction loss.

The SY8366H adopts the instant PWM architecture to achieve fast transient responses for high step down applications and high efficiency at light loads. In addition, it operates at pseudo-constant frequency of 800kHz under continuous conduction mode to minimize the size of inductor and capacitor.

Applications Information

Because of the high integration in the SY8366H IC, the application circuit based on this regulator IC is rather simple. Only input capacitor C_{IN} , output capacitor C_{OUT} , output inductor L and feedback resistors (R_1 and R_2) need to be selected for the targeted applications specifications.

Feedback resistor dividers R_1 and R_2 :

Choose R_1 and R_2 to program the proper output voltage. To minimize the power consumption under light loads, it is desirable to choose large resistance values for both R_1 and R_2 . A value of between 10k Ω and 1M Ω is highly recommended for both resistors. If V_{out} is 3.3V, $R_1=100k$ is chosen, then using following equation, R_2 can be calculated to be 22.1k:

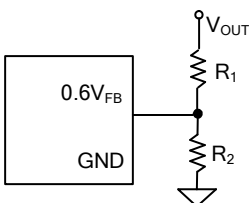
$$R_2 = \frac{0.6V}{V_{OUT} - 0.6V} R_1$$

Input capacitor C_{IN} :

The ripple current through input capacitor is calculated as:

$$I_{C_{IN_RMS}} = I_{OUT} \cdot \sqrt{D(1-D)}$$

To minimize the potential noise problem, place a typical X5R or better grade ceramic capacitor really close to the IN and GND pins. Care should be taken to minimize the loop area formed by C_{IN} , and IN/GND pins. In this case, a 10uF low ESR ceramic capacitor is recommended.

Output capacitor C_{OUT} :

The output capacitor is selected to handle the output ripple noise requirements. Both steady state ripple and transient requirements must be taken into consideration when selecting this capacitor. For most applications, an X5R or better grade ceramic capacitor greater than 66uF capacitance can work well. The capacitance derating with DC voltage must be considered.

Output inductor L :

There are several considerations in choosing this inductor.

- 1) Choose the inductance to provide the desired ripple current. It is suggested to choose the ripple current to be about 40% of the maximum output current. The inductance is calculated as:

$$L = \frac{V_{OUT}(1 - V_{OUT}/V_{IN,MAX})}{F_{SW} \times I_{OUT,MAX} \times 40\%}$$

where F_{sw} is the switching frequency and $I_{OUT,MAX}$ is the maximum load current.

The SY8366H regulator IC is quite tolerant of different ripple current amplitude. Consequently, the final choice of inductance can be slightly off the calculation value without significantly impacting the performance.

- 2) The saturation current rating of the inductor must be selected to be greater than the peak inductor current under full load conditions.

$$I_{SAT, MIN} > I_{OUT, MAX} + \frac{V_{OUT}(1 - V_{OUT}/V_{IN,MAX})}{2 \cdot F_{SW} \cdot L}$$

- 3) The DCR of the inductor and the core loss at the switching frequency must be low enough to achieve the desired efficiency requirement. It is desirable to choose an inductor with $DCR < 10m\Omega$ to achieve a good overall efficiency.

Current limit setting

The current limit is set to 6A, 9A or 12A when ILMT pin is pull low, floating or pull high respectively.

Soft-start

The SY8366H has a built-in soft-start to control the rise rate of the output voltage and limit the input current surge during IC start-up. The typical soft-start time is 600us.

Enable Operation

Pulling the EN pin low (<0.4V) will shut down the device. During shutdown mode, the SY8366H shutdown current drops to lower than 10uA, Driving the EN pin high (>0.8V) will turn on the IC again.

External Bootstrap Cap

This capacitor provides the gate driver voltage for internal high side MOSEFET. A 100nF low ESR ceramic capacitor connected between BS pin and LX pin is recommended.

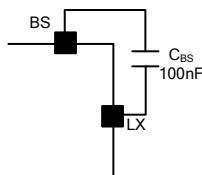

VCC LDO

The 3.3V VCC LDO provides the power supply for internal control circuit. Bypass this pin to ground with a 2.2uF ceramic capacitor.

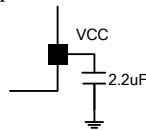

Power Good Indication

PG is an open drain output. This pin is externally pulled high when the FB voltage is within 90% to 120% of the internal reference voltage. Otherwise is pulled low.

Load Transient Considerations:

The SY8366H regulator IC adopts the instant PWM architecture to achieve good stability and fast transient responses. In applications with high step load current, adding an RC network R_{FF} and C_{FF} parallel with R_1

may further speed up the load transient responses.

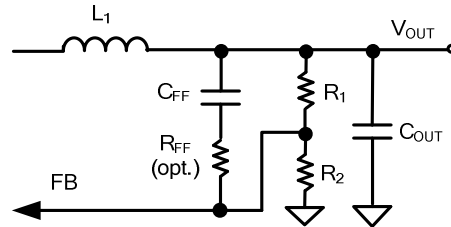

Layout Design:

The layout design of SY8366H regulator is relatively simple. For the best efficiency and minimum noise problem, we should place the following components close to the IC: C_{IN} , C_{VCC} , L , R_1 and R_2 .

1) It is desirable to maximize the PCB copper area connecting to GND pin to achieve the best thermal and noise performance. If the board space allowed, a ground plane is highly desirable.

2) C_{IN} must be close to Pins IN and GND. The loop area formed by C_{IN} and GND must be minimized.

3) The PCB copper area associated with LX pin must be minimized to avoid the potential noise problem.

4) The components R_1 and R_2 , and the trace connecting to the FB pin must NOT be adjacent to the LX net on the PCB layout to avoid the noise problem.

5) If the system chip interfacing with the EN pin has a high impedance state at shutdown mode and the IN pin is connected directly to a power source such as a Li-Ion battery, it is desirable to add a pull down 1Mohm resistor between the EN and GND pins to prevent the noise from falsely turning on the regulator at shutdown mode.

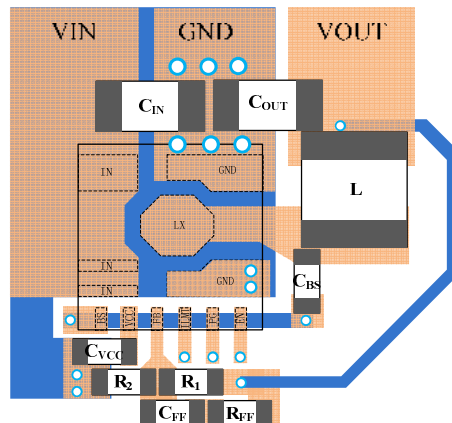

QFN3x3-12 Package Outline Drawing

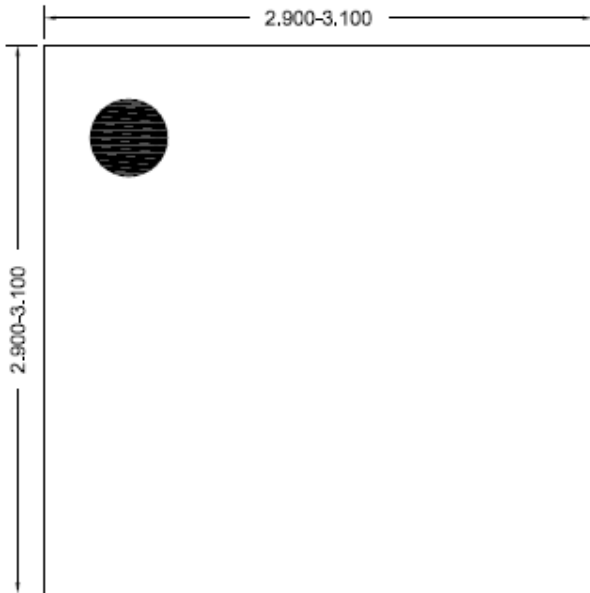

Top View

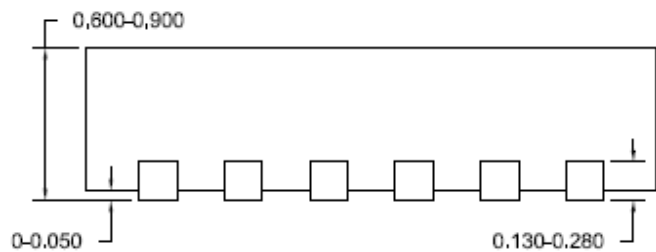

Side View

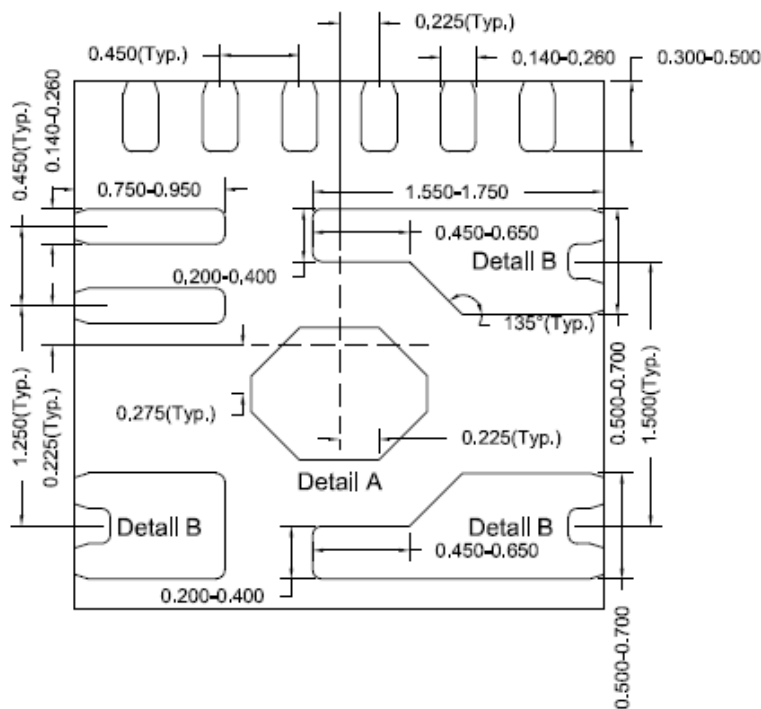

Bottom View

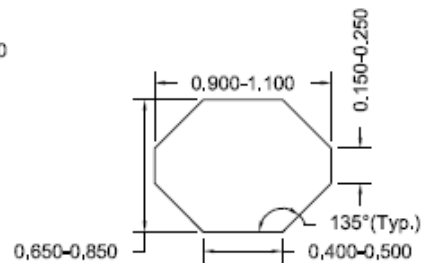

Detail A



Detail B

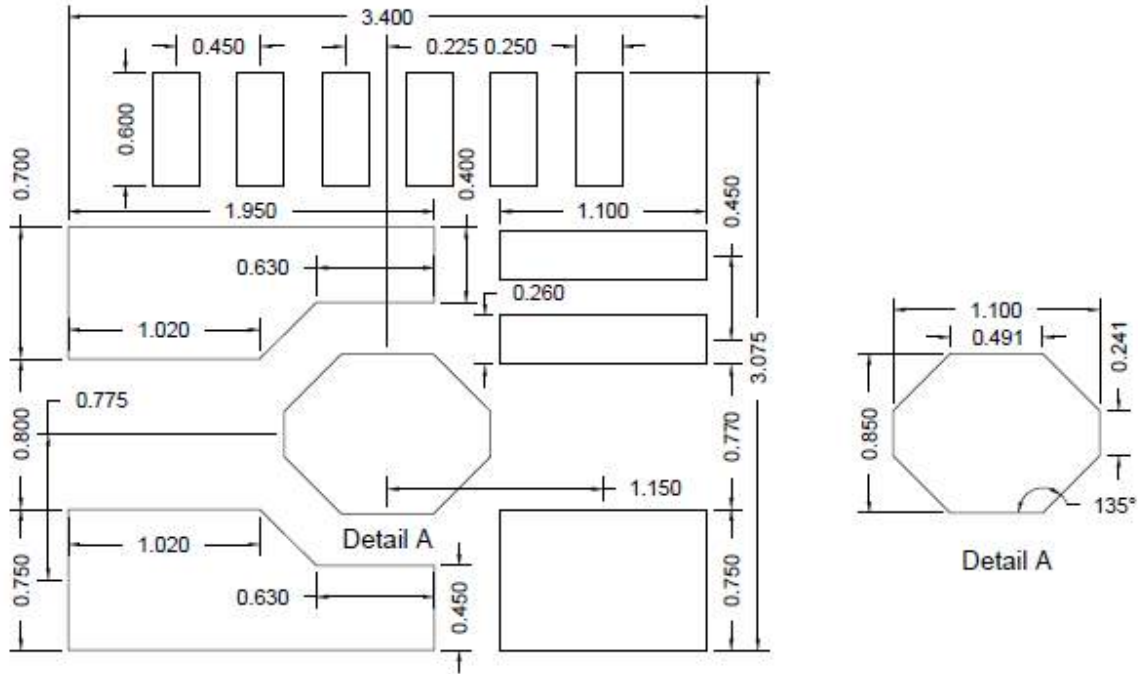

**Recommended PCB layout
(Reference Only)**

Notes: All dimension in MM and exclude mold flash & metal burr.

Taping & Reel Specification

1. QFN3x3-12 taping orientation

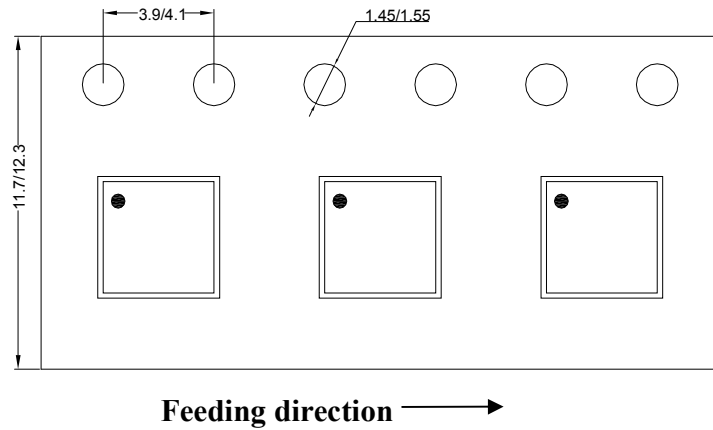

2. Carrier Tape & Reel specification for packages

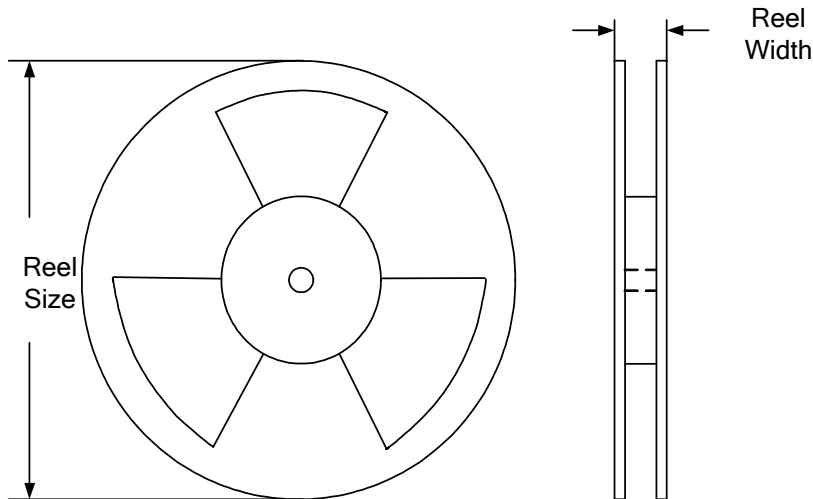

Package types	Tape width (mm)	Pocket pitch(mm)	Reel size (Inch)	Reel width(mm)	Trailer length(mm)	Leader length (mm)	Qty per reel
QFN3x3	12	8	13"	12.4	400	400	5000

3. Others: NA